



G2500

Operator Manual

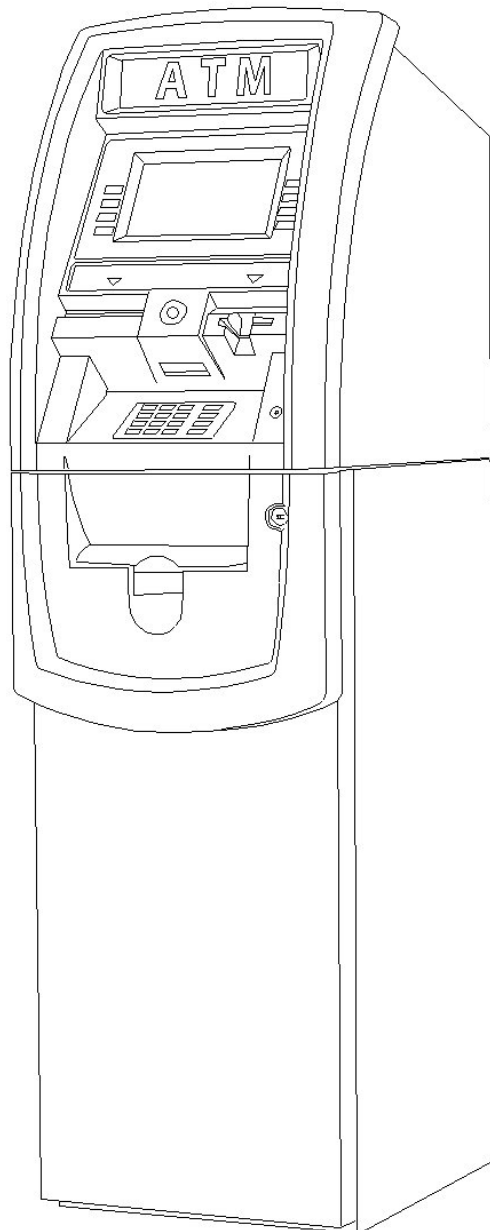

TABLE OF CONTENTS

1. INTRODUCTION

1.1 Features

1.1.1 Genmega G2500™ Series ATM

1.2 Specifications

Genmega G2500™ Specifications

1.2.1 Dimensions and Component Locations

1.2.2 Front Panel Identification

1.2.3 Cash Dispensing Unit

1.2.4 Receipt Printer

1.2.5 Main Control Board

1.2.6 Operating Environment

1.3 Warranty/Service

2. INSTALLATION

2.1 Genmega G2500™ Installation

2.1.1 Unpacking

2.1.2 Physical Installation

2.1.3 Hardware Setup

3. PROGRAMMING

3.1 Initial Setup

3.1.1 Accessing the Operator Function Menu

3.1.2 When an Error Occurs

3.1.3 EPP Keypad

3.2 The Host Setup Menu

3.2.1 Key Management

3.2.2 Set Terminal ID Number

3.2.3 Connect Timer

3.2.4 Set Routing ID Number

3.2.5 Set Host Telephone Number

3.2.6 Health Check Message

3.2.7 Remote Monitor

3.2.8 Trial Day Total

3.3 The System Setup Menu

3.3.1 Set Clock

3.3.2 Optional Languages

3.3.3 Speaker Volume

3.3.4 ISO 1/3 En/Disable

3.3.5 Change Passwords

3.3.6 Device Setup

3.3.7 Set Reboot Time

3.3.8 Serial Number

3.4 Customer Setup Menu

3.4.1 Change Message

3.4.2 BIN Lists

3.4.3 Optional Features

3.4.4 Change Processor

3.4.5 Surcharge Mode

3.4.6 Graphics

3.5 Transaction Setup

- 3.5.1 Dispense Limit
- 3.5.2 Denomination
- 3.5.3 Fast Cash
- 3.6 TCP/IP Setup

4. **OPERATION**

4.1 Opening and Closing

- 4.1.1 Opening the Security Door
- 4.1.2 Closing the Security Door
- 4.1.3 Opening the top Bezel
- 4.1.4 Closing the top Bezel
- 4.1.5 Operating and Changing the Combination Lock
- 4.1.6 Operating and Changing the Electronic Lock

4.2 Cash Operations

- 4.2.1 Adding Cash to the Cassette (TCDU)
- 4.2.2 Emptying the Reject Bin (TCDU)
- 4.2.3 Adding Cash to the Cassette (MCDU)
- 4.2.4 Emptying the Reject Bin (MCDU)
- 4.2.5 Loading the Receipt Printer

4.3 Settlement Menu

4.4 Journal Menu

4.5 Reports Menu

5. **DIAGNOSTICS**

5.1 Diagnostics Menu

6. **CUSTOMER TRANSACTIONS**

- 6.1 Opening Procedure
- 6.2 Withdrawal Transaction
- 6.3 Balance Inquiry Transaction
- 6.4 Transfer Transaction
- 6.5 Closing Procedure
- 6.6 Error Recovery

APPENDIX

- A. Error Codes
- B. Clear NVRAM
- C. Master Key installation
- D. Custom Screen Graphics

FEATURES

1.1.1 The Genmega G2500™

Introducing the Genmega G2500 series retail ATM. Designed and engineered to meet the needs of the highly competitive retail ATM market, this innovative machine combines all the features you expect, built on a flexible platform allowing you to custom fit each machine to its location and traffic volume.

Packed with features like an 8" high-resolution LCD screen (10" Touch-Screen for 3500 model) ready for your custom advertisements and a DIP type card reader (EMV / Chip-Card reader available). The G2500 Series vault has been reinforced along the door edge to help prevent physical attacks.

In addition to the dispensing options offered by Genmega, including drawer, cassette, and multi-cassette devices, the Genmega G2500 series supports several other popular dispenser models including the De La Rue SDD®, the Teanam GBM® and the Puloon LCDM1000® providing an economical upgrade for existing machines

H/W FEATURES

- UL 291 Business Hour Service Vault featuring reinforced steel bottom & dial lock
- 8" high-resolution, wide-screen TFT LCD (Optional 10" Touch Screen – 3500 Model)
- 56K modem + Ethernet TCP/IP with SSL encryption
- 800 note fixed cassette dispenser (TCDU)
- 1000 note removable cassette dispenser (SCDU)
- 1700 note removable cassette dispenser (MCDU)
- Dual Cassette 3400 note (1700x2) HCDU dispenser
- DIP-type magnetic card reader (EMV Optional)
- 2" and 3" (optional) Thermal receipt printer
- Modular design for easy maintenance
- Lighted transaction guidance system
- Meets ADA Standards for Height, Reach and Keypad layout

FUNCTIONAL FEATURES

- Electronic journal stores over 40,000* transactions
 - *(can be downloaded via USB or SD memory)
- Supports English, Spanish and French and Korean languages
- Availability for 8 on screen advertisement graphics
- Detailed average history report feature
- On-screen error code descriptions for easy service

1.2 SPECIFICATIONS

Genmega G2500™ SPECIFICATIONS

1.2.1 Dimensions and Component Location

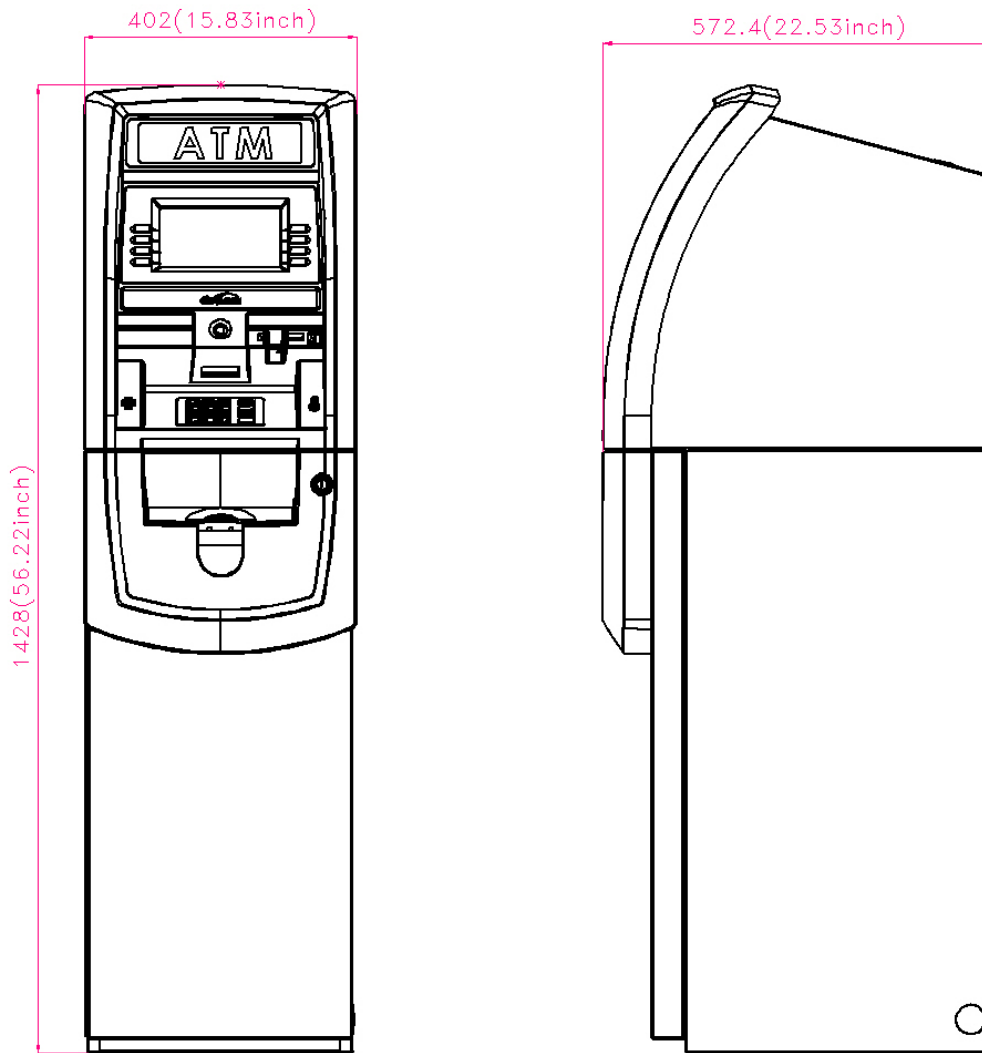

WEIGHT: 206 lbs.

Height = 56.22"

Width = 15.83"

Depth = 22.53"

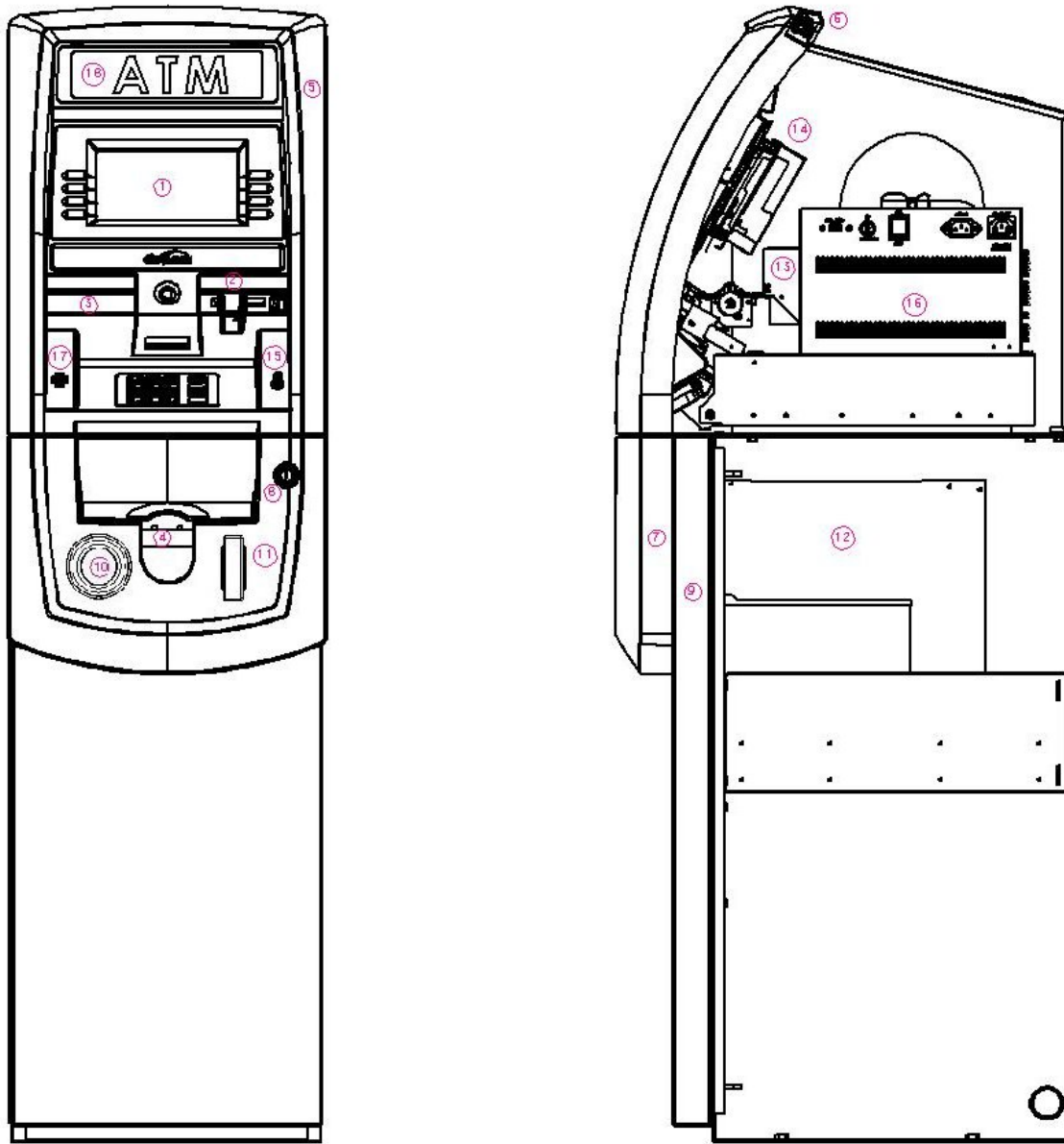

Component Location

- | | |
|--------------------------|--------------------------|
| 1. LCD & Customer Keypad | 11. Security Door Handle |
| 2. Card Reader Slot | 12. Cash Dispensing Unit |
| 3. Receipt Printer Slot | 13. Receipt Printer |
| 4. Cash Tray | 14. Main Control Board |
| 5. Front Panel | 15. Ear Phone Jack |
| 6. Front Panel Lock | 16. Power Supply |
| 7. Security Cover | 17. Speaker. |
| 8. Security Cover Lock | |
| 9. Security Door | |
| 10. Combination Lock | |

1.2.2 Front Panel Identification



Fig. 3 Front Panel Identification

LCD

Screen Size: 8" / Optional 10" Touch Screen (3500 Model)

TFT LCD

Resolution: 800 x 480 WVGA

Display Characters: 40 x 15 (Standard Characters)

8 LCD Function Keys

KEYPAD

Certified VISA / Interac compliant EPP (Encrypting Pin Pad)

Voice Guidance Port

Voice assisted operation available through the headphone jack on the front bezel

1.2.3 Cash Dispensing Unit

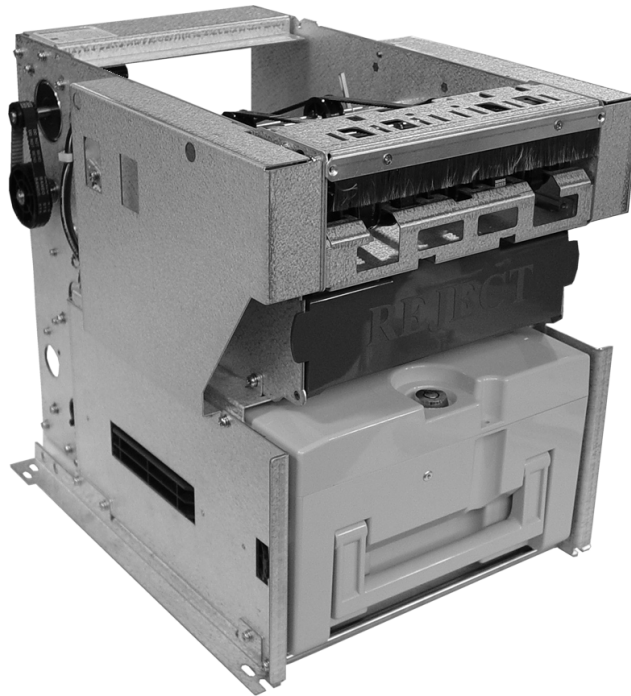

Cash Dispensing Unit
(1000 Note - SCDU)

CASH DISPENSING UNIT

Dispensing Speed: 2.5 notes/second
Capacity of 800 new notes (fixed cassette)
Capacity of 1000 or 1700 notes (removable)
Reject Bin
Double note detect module
Support for polymer notes (Canada)

*Optional dispensers include:
1700 note removable cassette
MCDU

3400 note dual-cassette
(1700x2) HCDU

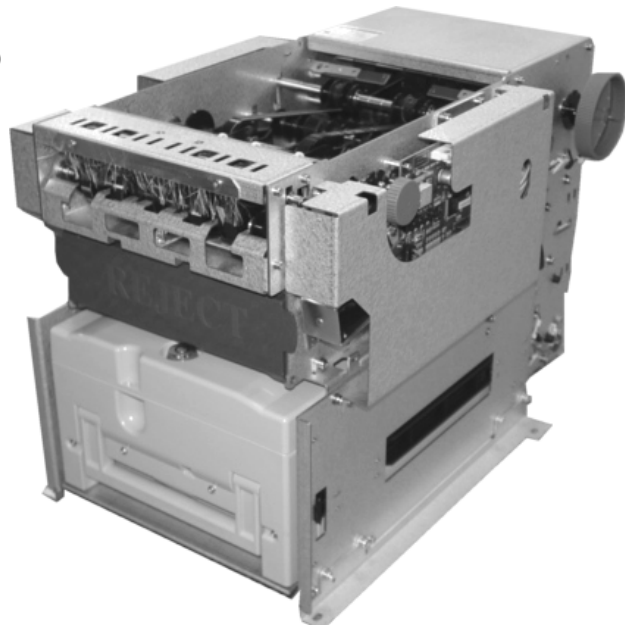

1.2.4 Receipt Printer

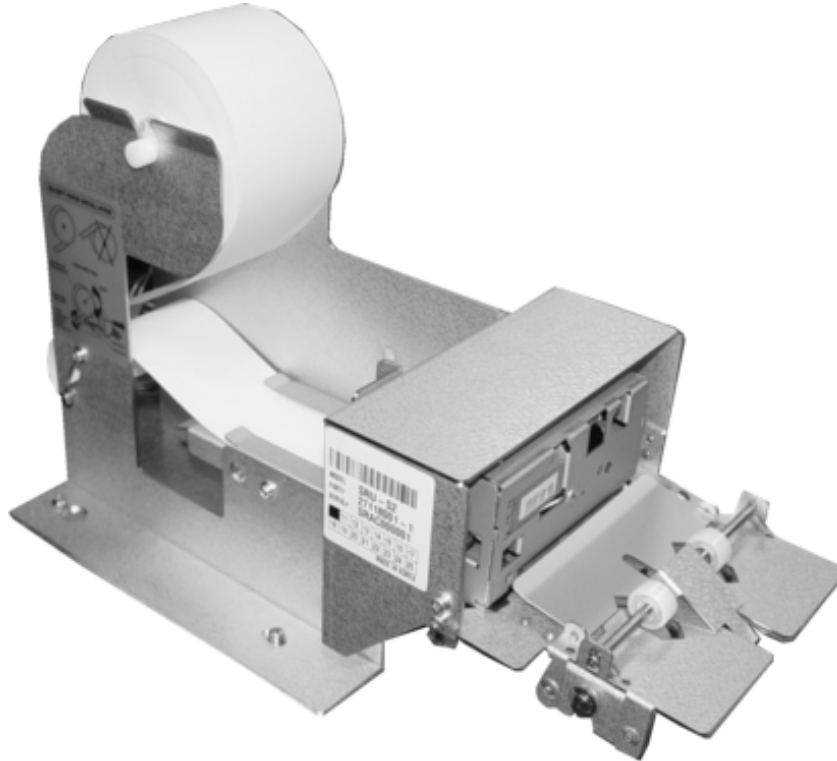

Receipt Printer

RECEIPT PRINTER

Thermal line printer
36 characters/line
Semi-automatic roll paper setting
Motorized front push rollers

PAPER SPECIFICATIONS

One sided thermal paper
Factory paper is thermal side out (but either way will work)
6 inch outside diameter roll
2 ¼" inch wide (3" wide printer optional)
Core inside diameter 11/16 inch
21# weight (paper thickness)

Optional 3" Printer supports printing of receipt graphic

1.2.5 Main Control Board

Samsung S3C2440AL-40 RISC 32-bit CPU
64 MB RAM
WinCE™ 5.0 Operating System
Modem: 56,000 bps dial-up modem
TCP/IP Ethernet connection - Onboard SSL
Electronic Journal: 40,000 transactions (upload to USB or SD memory Device)
Battery back-up for set-up parameters (NVRAM)
Real time clock

1.2.6 Operating Environment

POWER REQUIREMENTS

110/220 VAC \pm 10%, 50/60 Hz, 145 Watts

POWER CONNECTIONS

For warranty purposes, Genmega requires the G2500™ series ATM be connected to a dedicated power circuit (5amp recommended). This circuit must consist of line, neutral, and ground leads connected directly to the power circuit breaker panel. This circuit should not be shared with any other equipment. Use of a surge protector or uninterruptible power supply is recommended.

PHONE LINE REQUIREMENTS

The Genmega G2500 must be connected to a dedicated analog phone line. This line must be a direct-dial analog line. It is important to disable any voice-mail included on that phone line as it will cause the ATM not to dial out. This line should not be shared with any other equipment at the location. Use of shielded (CAT5) phone cable is also recommended for best performance and to reduce the chance of interference. 'Digital' phone lines are NOT supported.

NETWORK (TCP/IP) REQUIREMENTS

For connection to processor via TCP/IP, use an Ethernet Patch-Cable (not included). The ATM must connect to a device (Router) that can provide DHCP support unless a static IP address is assigned by the service provider. It is recommended the ATM connect to a broadband router (Linksys, Netgear, Belkin) or similar device rather than directly to a Cable/DSL modem. For advanced or corporate networks, provide the IT staff with ATM Host IP address and Host Port information (available from your ISO).

TEMPERATURE

In storage : 32°F - 123°F (0°C ~ 49°C)
While operating : 40°F - 95°F (5°C ~ 35°C)

HUMIDITY

In storage : 10% < RH < 90%, non-condensed
While operating : 15% < RH < 85%, non-condensed

1.3 WARRANTY/SERVICE

MANUFACTURERS WARRANTY

Genmega, Inc. provides a limited one-year parts warranty for the G2500™ series ATM. Genmega guarantees your G2500™ model ATM to be free from defects in materials and workmanship.

The one-year parts warranty begins 15 days from the original ATM shipping date.

WHAT IS COVERED:

- Cash Dispensing Unit (CDU) and Cash Cassette
- Receipt printer (SHU)
- LCD module
- Magnetic Card Reader (MCR)
- EPP Keypad
- Power Supply
- Mainboard (CE)
- Lock and locking mechanism ****LIMITED 90 DAY WARRANTY****
Dial and Electronic locks will be covered by a limited 90-day warranty beginning 15 days from shipping date. Should the lock fail under normal use, Genmega will replace the lock only. Services required to open the vault and or replace the lock are at the expense of the ATM owner.

WHAT IS NOT COVERED:

- Power cable and modem cable
- Key lock and key
- Plastic Bezels
- Software upgrade
- Receipt printer jam
- Note jam
- Forgotten password or combination of lock
- Any damages from misuse, improper installation, and vandalism
- Any damages from “brown out” or low power, lightning, or any other ‘acts of God’

Your distributor/dealer may offer an enhanced or extended warranty in addition to the original manufacturers one-year warranty. Once the manufacturers warranty has expired, all claims for warranty service must be resolved directly between the distributor/dealer and the ATM owner.

OBTAINING SERVICE: If you have any problems or questions about your Genmega ATM, your dealer or distributor is your primary contact for assistance/service. Your manufacturers warranty is provided through your dealer or distributor.

INSTALLATION

2.1 Genmega G2500™ INSTALLATION

2.1.1 UNPACKING

Step 1

Upon receipt of your new Genmega ATM, check the box and packaging for any damage. If you suspect any damage, mark the shipping receipt to indicate suspected concealed damage. Do not discard the ATM packaging materials until you have verified any shipping damage claim. Contact your distributor immediately if you see any shipping damage. It's also advisable to take photos of any damage.

NOTE: You have 7 days from delivery to report any concealed damage. After 7 days we are unable to process any shipping damage claims.

Step 2

Verify the contents carefully with the packing list to make sure all items listed are included per your order. Notify your distributor of any shortages.

2.1.2 PHYSICAL INSTALLATION

To install the Genmega G2500™ ATM, review the following steps:

Step 1

Place the system on a flat surface during installation. The system is top-heavy and has a tendency to tip over. Be very careful when opening the top or bottom slide trays or vault door prior to bolting down the ATM, it will be more likely to tip.

Step 2

Use the holes in the bottom of the vault to mark the floor or ATM location. Remove the ATM before drilling the anchor holes. Anchors are not included with the ATM.

WARNING: Do not drill the holes through the vault. Dust from the drilling will damage ATM components and void your warranty.

Due to variations in flooring and building codes, Genmega does not recommend a particular size or type of anchor as each installation. Consult anchor manufacturers instructions for proper installation. Maximum anchor diameter is ½.

Step 3

Place the G2500™ ATM on top of the anchors and tighten. Note that over-tightening the anchors can cause the vault to go out of square and make door operation difficult. If this occurs, back off the anchors or use leveling bolts.

Step 4

Open the vault door bezel with the key provided. See page 4.1 for Opening and Closing instructions.

Step 5

Using the supplied combination (see lock manual for default combination), open the Vault door. The default combination should be changed as soon as possible. Refer to page 4.5 (dial) or 4.7 (electronic) for instructions on opening or changing the lock.

2.1.3 HARDWARE SETUP

Step 1

Verify the incoming power voltage (115/220V) for your location and check the switch on the power supply of the ATM (should be defaulted to 115V)



Step 2

Verify that the telephone line or internet connection for the ATM is in proper working order. Make sure there is no voicemail on the line (pulse noise when you first lift the receiver). NOTE – Digital phones lines are not supported by this ATM.

Step 3

Open the security door. See page 4.1 for assistance.



Use this key (2 included) to open the top and bottom bezels

Cassette key
(removable cassette)

Cassette key
(fixed cassette)

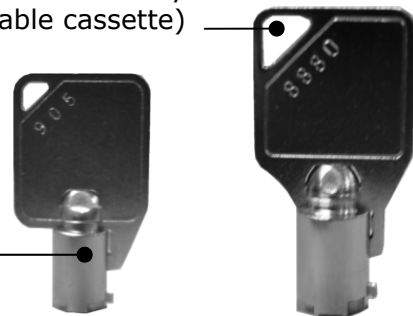

Step 4

Remove the cash cassette from its packing box (removable cassette dispensers only). Fill the cassette or cash drawer with the appropriate amount of notes, and carefully place it in the Cash Dispensing Unit. Place the appropriate denomination label on the front of the cassette. See page 4.9 for instruction.

Step 5

Before closing the vault, thoroughly test the combination lock by locking and unlocking the lock several times. It is much easier to diagnose potential lock problems before shutting the door.

Step 6

Open the top of the ATM. Place the receipt paper in the Receipt Printer. The paper prints only on one side (shiny side) always check the roll when you install paper. Place the roll so that the coated side (shiny side) will be facing up. See page 4.12 for paper loading instruction.

Step 7

Connect the Power cable and the telephone cable to the appropriate outlets on the wall. Verify that the AC power outlet is grounded (3 prong plug).

If you are installing an optional topper sign, install the power cord through the top housing and plug the topper into the open connector (white) located on the back of the slide tray. Make sure the cable has enough slack to allow the slide tray to open completely.

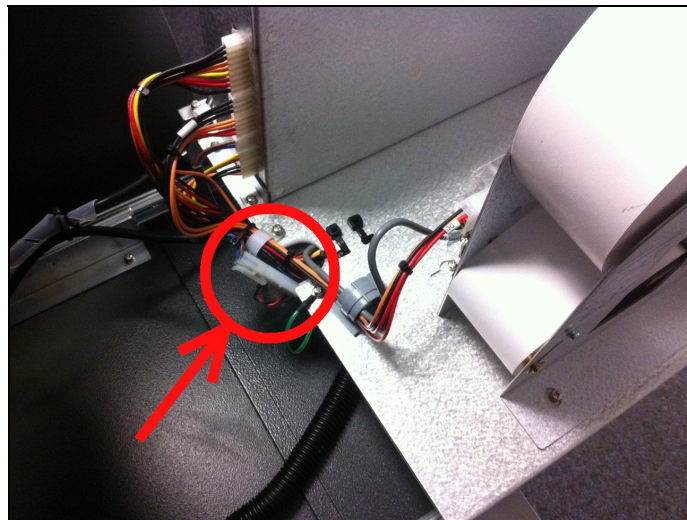

Step 8

Turn the power on and verify that all systems are operational. If any part on the system or its programming is not operational, an error code will be displayed along with instructions. If the error cannot be corrected, please contact your distributor for help. If no error code is displayed, check the Error Summary.

PROGRAMMING

3.1 INITIAL SETUP

3.1.1 ACCESSING THE OPERATOR FUNCTION

To access the Operator Menu, press these keys in order [ENTER] – [CLEAR] – [CANCEL] – [1] – [2] – [3].

Note: The Operator Function menu can only be accessed when the machine is either in service (“insert your card” screen) or out of service. If the machine is attempting to connect to the host or initializing, you will not be able to use the key commands to access the Operator Function Menu.

If you have difficulty accessing the Operator Menu, power off the ATM and then either open the vault door or remove the cassette from the dispenser and then power back on. This will force the ATM to the Operator Menu. (See Step 1 on 3.3)

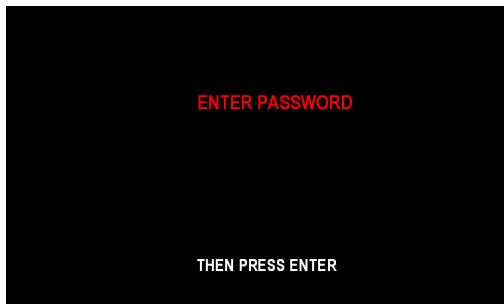

Once you successfully completed the key combination, you will be prompted to enter a password. There are 3 levels of passwords.

- Operator Password (allows access to basic menu structure)
- Service Password (allows access to basic and diagnostic menus)
- Master Password (allows access to all menus including setup parameters)

You must press ENTER key after typing the password!

Passwords are very important to maintaining security for your ATM. Your dealer/distributor will provide you with default password information.

WARNING: Genmega highly recommends changing your passwords from default as soon as possible. Keep all passwords safe and restrict access to non-authorized personnel.

Passwords **MUST** be 6 digits in length, use of anything other than a 6 digit password may cause the passwords to revert back to factory default.

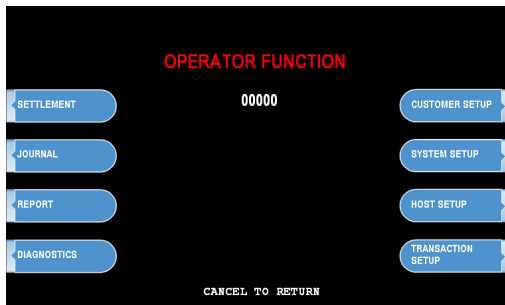

Shown the left is the complete Operator Function menu, depending on which password you entered (operators, service, master) you may not see certain functions. For example, if you use an operator password you will not see the Host Setup button, as you will not have access to that menu.

3.1.2 WHEN AN ERROR OCCURS

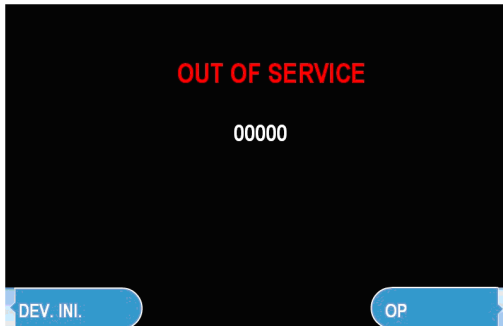

Step 1

From this screen, press (OP) Operator Menu, to access the Main Menu.

Dev. Ini. Will reinitialize the machine and reboot.

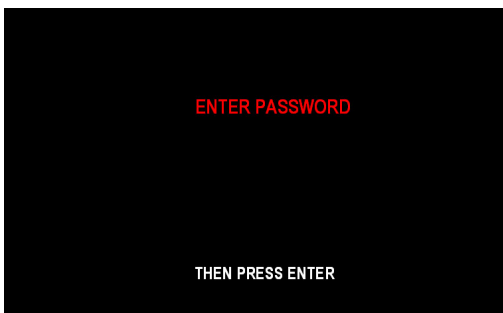

Step 2

“ENTER PASSWORD” will be displayed. Enter the Master, Service or Operator Password to continue.

Contact your distributor for default passwords.

Remember to press the ENTER key after typing password!

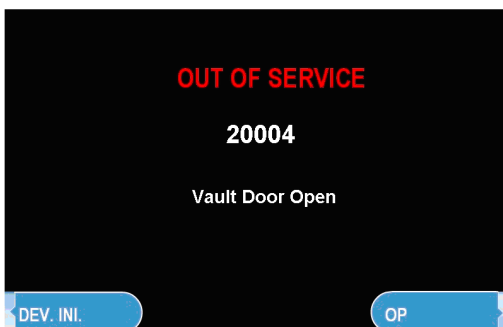

Step 3

NOTE: If the machine goes out of service, the error code will not always appear on the screen. If you do not see an error code, enter operator function and go to reports.

Look in the error summary for error codes.

3.1.3 Function Keys and EPP Keypad



G2500 LCD display Function Key layout

This keypad layout and table below will help while learning how to input text and numbers while programming your Genmega ATM. When in a text entry screen, the F1, F3 and F5 keys are used to switch character maps between upper and lower case as well as special characters.

	0	1	2	3	4	5	6	7	8	9
F1 Alphabet Upper	+ - =	Space Q Z	A B C	D E F	G H I	J K L	M N O	P R S	T U V	W X Y
F3 Alphabet Lower	+ - =	Space q z	a b c	d e f	g h i	j k l	m n o	p r s	t u v	w x y
F5 Number Special	0 ()	1 []	2 { }	3 < >	4 , .	5 ! \$	6 ' "	7 % *	8 : ;	9 ? /

The above table is displayed on screen when entering text, this is for reference only.

3.2 HOST SETUP

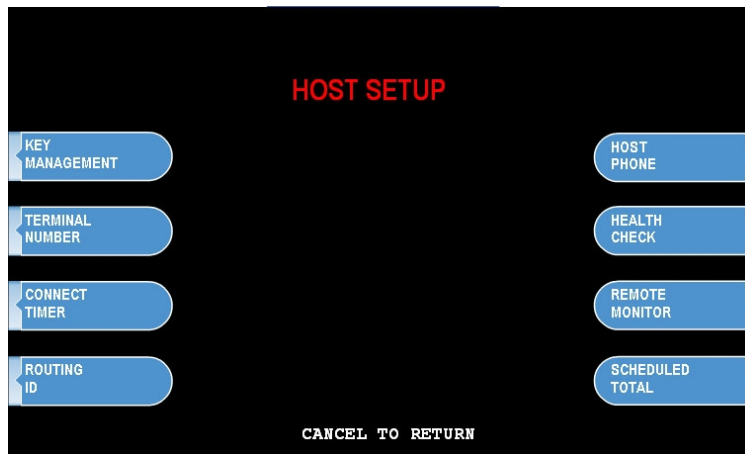

The Host Setup menu provides access to the parameters necessary to connect the ATM to the processor. Master Password is required to access most of these options; however Service password allows basic access for troubleshooting purposes.

3.2.1 KEY MANAGEMENT

Access to Key Management requires entering a “Secure Mode” which engages additional security measures (per VISA specification) to prevent Master Key tampering. Make note of these changes as it does affect how keys are entered.

Entering Key Management requires two 6-digit passwords. By default these will be “000000” for part #1 and “000000” for part #2.

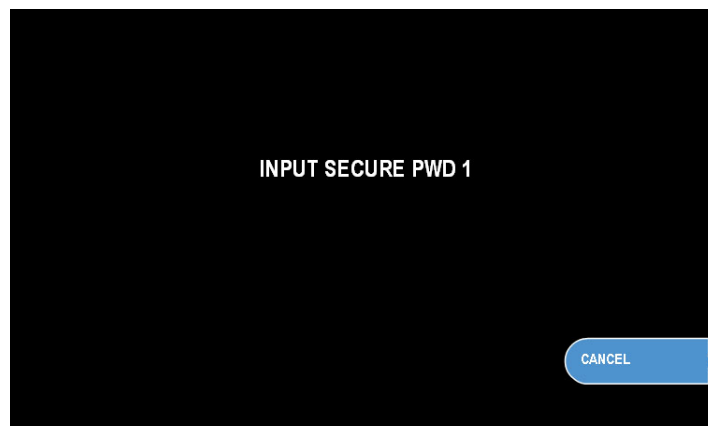

If a mistake is made entering the “Secure Mode” password, you will be prompted to wait 30 seconds to reattempt.

NOTE: In compliance with PCI specifications, you must change the Secure Mode Passwords from default before any Master Keys can be entered. After changing the Secure Mode Passwords, you must exit completely from the Operator Menu, and reboot the machine. After this step, you can enter Master Keys.

Successful entry of both passwords will grant access to the Key Management screen. From the moment the Key Management area is entered, a 5 minute timer begins. At the end of 5 minutes, regardless of what you are doing (entering a master key for example) the Key Management area times out and you will be taken back to the Host Setup menu. Making a mistake during this process can start a 30 second reset timer.

If you are ever forced to wait for the 30 second retry timer, back all the way out of the menus and wait a full 30 seconds before retrying or the timer will not reset.

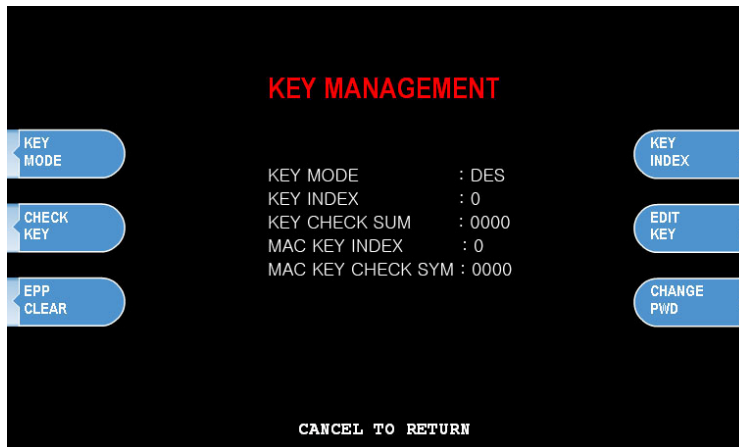

KEY MODE

This option sets the type of master key you will be loading (TDES, DES, MAC etc.) Refer to Addendum C for Key Mode descriptions and instructions.

MASTER KEY INDEX

The ATM will hold up to 16 individual Master Keys. Check with your processor to find if they are expected to be at a certain location. For example Coredata is always installed at index #9, most other processors are installed at index #0 or #1. The ATM will only use the key that the index is set to regardless of how many keys are installed. To set the index simply press the button labeled Master Key Index and then enter the number you want it set to (enter as a 2 digit number ... 00, 01, 02, 10, 11 etc.) press Enter when done. Press Check Master Key to see a list of currently installed keys.

CHECK MASTER KEY

This will show the list of available master keys and their appropriate checksums. The checksum is a 4 digit number calculated from the two 16-digit numbers of your master key that provides a means to verify the master key is correct. When your processor provides your Master Keys, they will also give you the 4 digit checksum. If after entering your Master Key this checksum does not match, try reentering your master keys or contact the processor.

EDIT MASTER KEY

This is where you enter your two 16-digit Master Keys (provided by your processor). After pressing Edit Master Key, you will be prompted to enter an index where you want this key stored. If you do not know which index to use, contact your dealer or processor. Generally, you should use index 0 or 1 unless otherwise instructed.

CHANGE PASSWORD

This allows you to set each part of the “Secure Mode” Password. As with the other passwords used in the G2500™, each must be a 6 digit number. If you change the password and cannot remember it, you must clear RAM on the pin pad to reset.

NOTE: In compliance with PCI specifications, you must change the Secure Mode Passwords from default before any Master Keys can be entered. After changing the Secure Mode Passwords, you must exit completely from the Operator Menu, and reboot the machine. After this step, you can enter Master Keys.

Entering Master Keys:

Use the chart below for entering Master Keys from the main pin pad. Master Keys (or Key Management) cannot be entered from the optional Rear Service Panel. Please see Appendix for specific Master Key instructions.

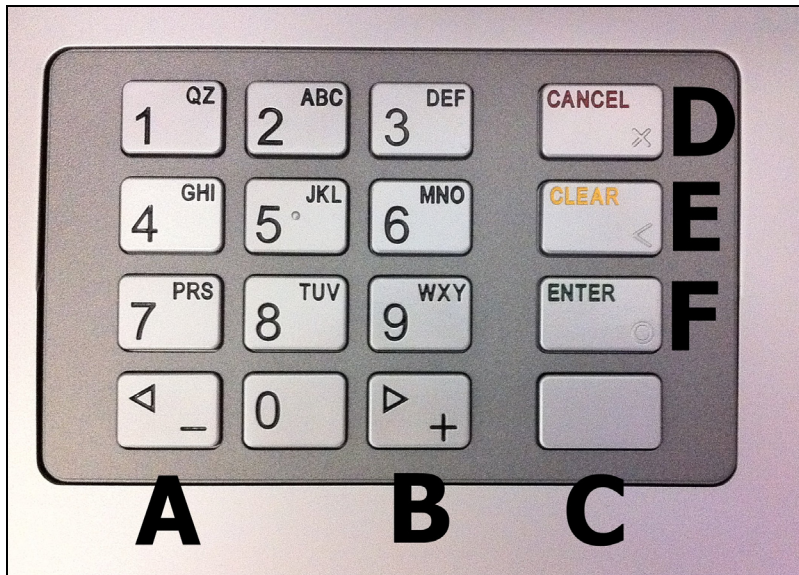

NOTE: The keypad above is EPP-B1 PCI / Interac certified EPP Device. Previous models of Genmega EPP (PCI Only) had the Enter and Cancel keys reversed from what is displayed above. If entering keys on the PCI only keypad, remember that the Enter key is always F and the Cancel key is always D.

3.2.2 SET TERMINAL ID NUMBER

Step 1

From the Host Setup Menu, go to Terminal ID. Terminal ID number is provided by the processor and is individual for your ATM. It identifies your ATM on the network and any transactions done on your machine will be linked to that number. This number is obtained either through your dealer or processing company.

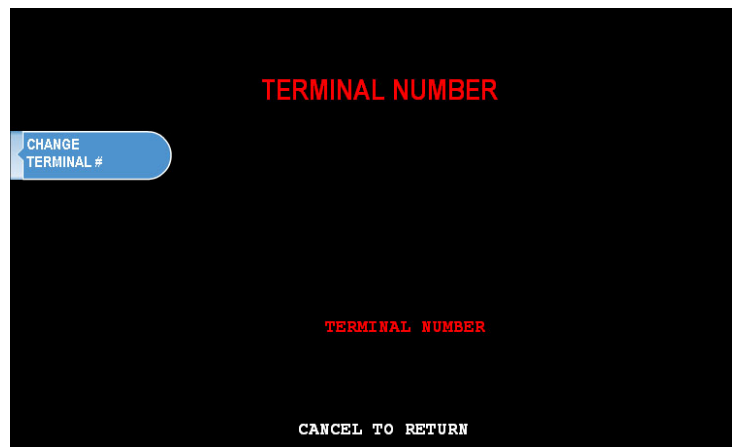

3.2.3 CONNECT TIMER

The connect timer is the setting which determines how long the machine will wait to connect when trying to dial into the processor. Default time is 60 seconds. Lowering this may improve connection speeds but at the risk of reliability.

3.2.4 SET ROUTING ID NUMBER

From the Host Setup Menu, go to Routing ID. The Routing ID is unique to each processor and identifies the machine by processor. This number is obtained either through your dealer or processing company.

NOTE: If using Standard 3 (Extended Messaging) Routing ID becomes COMS ID

3.2.5 SET HOST TELEPHONE NUMBER

Step 1

From the Host Setup Menu, go to Telephone Number.

Step 2

You can enter a Primary (Host Phone 1) and a Secondary (Host Phone 2) for the machine to connect to the processor. These phone numbers are available from your dealer or the processor (you can also reference the quick installation guide enclosed with this ATM for numbers for the common processors).

Step 3

Once you have selected Host Phone #1 or Host Phone #2 you will be prompted with the following screen. Using the numbers on the keypad press the first number of your phone number.

Configuration Scheduled: When this option is set to 'Scheduled', upon backing out of the menu and going back in service, the ATM will initiate a configuration request with the host and download a new working key. Because the ATM reboots itself every 24 hours, this option must be enabled to initiate the request.

Note that if you reprogram the machine, or change any important parameters related to the host, you should toggle the value to 'scheduled' and update configuration with the host, not doing so can give you a 'Welcome' screen even though the host is not properly connected resulting in transactions being denied.

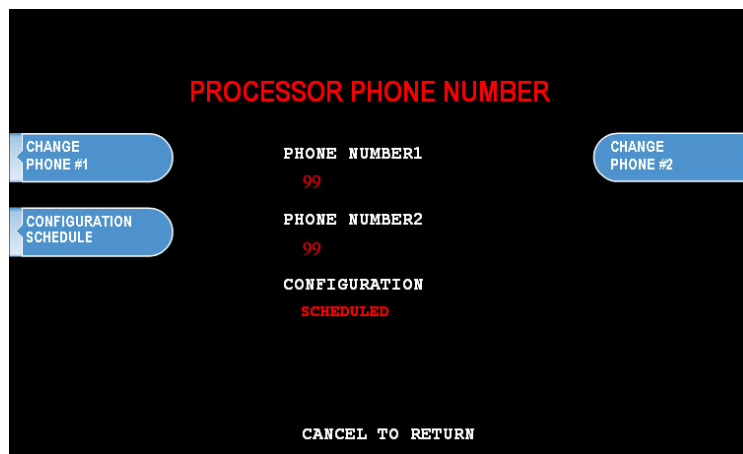

Step 4

Genmega always recommends using a dedicated, data-quality phone line for all ATM installations, however if you are using a phone line that is dialing out through a PBX type system (where you dial a number for an outside line), then you may insert commas (,) to create a pause between digits.

For example if you have to dial a 9 to get an outside line try the following:

9,,18005551212

(the 800 number being an example)

NOTE: Entering anything other than a number or a comma in the host phone number field will cause the ATM not to dial out. Make sure that Zero's and 'O's' are identified properly.

3.2.6 HEALTH CHECK MESSAGE

Health Check is an option that will send a system status signal to your processor at a set interval. Check with your dealer or processor to determine if they are prepared to receive this type of messaging.

To Enable, simply access the menu from Host Setup. Use the Host Send button to enable or disable the feature and the Message Send Interval button to set how often the machine will broadcast its status (in hours).

NOTE: When using Standard 1 processing mode, an option for 'Extended Health Check' may appear. This option is for 4 cassette dispensers and is not used in the G2500™

3.2.7 REMOTE MONITOR SYSTEM (RMS)

Remote Monitoring is the ability to dial into your ATM and send or retrieve information using Remote Management Software (RMS).

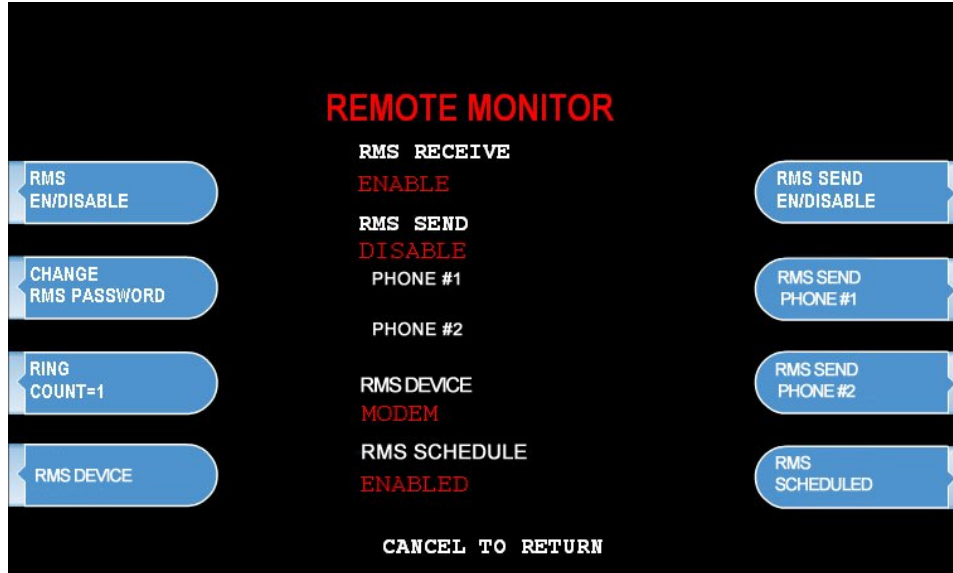

RMS EN / DISABLE

This will allow the ATM to be monitored remotely.

- Enable The ATM will answer incoming RMS calls.
- Disable The ATM will not answer any incoming calls.

RMS SEND

This feature enables the ATM to dial out to a computer running RMS software to report a malfunction, fatal error, out of service condition or to report status. Any time the ATM goes out of service for longer than 3 minutes, it will call the number (or IP address) programmed at Remote Phone #1 and then Remote Phone #2 if Remote #1 is busy. It will attempt this call 3 times. In order to use this feature you MUST have a PC with a modem and a dedicated phone line, or static IP address running RMS software available 24 hours a day.

- Enable The ATM will dial out to report out of service condition.
- Disable The ATM will NOT dial out to report out of service condition.

If you enable RMS Send, you MUST have phone numbers or IP address.

RMS PASSWORD

Remote monitoring is protected by a password that is checked when incoming calls from RMS occur. If the password does not match from an incoming RMS call, the call will be disconnected. The default password for RMS access is 333333. To change the password, press the password button and you will be prompted to enter your Master password. After entering your Master password, you will be prompted to enter the new RMS password (must be 6 digits) and then enter it again for verification. If you ever forget the RMS password, press password and follow the procedure again.

RMS SEND PHONE / IP

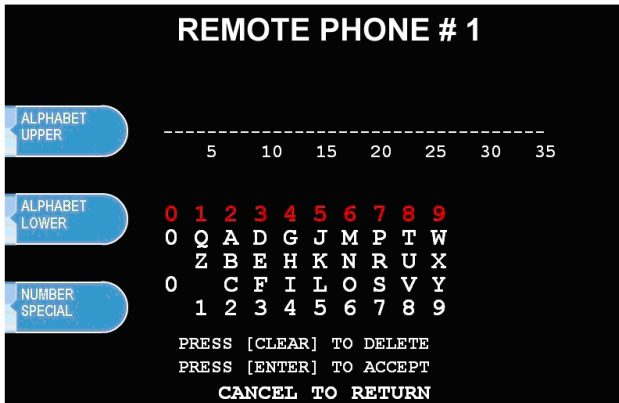

This is the number or IP address the ATM will call if there is an out of service condition. Press the button for either number and enter the number for the computer you want the ATM to call.

Using the numbers on the keypad press the first number of your phone number. You can use the <, > keys on the keypad to move back and forth (to correct any mistakes, or edit existing numbers).

RING COUNT (modem only)

This setting determines how many rings will elapse before the ATM will answer the phone. While this can be used in situations where the ATM phone line is shared with an additional device (like a fax or business phone) it's important to note that setting this value higher than 4 or 5 may result in monitoring software being unable to connect.

RMS DEVICE

This setting allows you to choose between modem or TCPIP as your communications for RMS.

When selecting TCPIP, do not change the RMS Send Port number (18458) This should always be left at default. You may need to alert your IT staff to unblock ports 18456 and 18458 if there is a firewall blocking access to these ports. If you're communicating from a home network, this will likely not be an issue.

RMS Schedule

When RMS Schedule is enabled, it will cause the ATM to initiate a call to the RMS PC at pre-set intervals to upload information and perform preset tasks. The primary purpose of this is for ATMs using TCPIP over the internet (or cellular/wireless), which cannot be contacted by RMS because they have a private IP address. Rather than try to provide each ATM with a publically addressable IP address, if you provide one address for your RMS PC, you can have the ATM call your RMS computer.

Public IP versus Private IP: If your ATM communicates through the internet, you can see the ATMs IP address in the TCPIP Setup Menu [System Setup Menu → Device Setup → ATM TCPIP]

If the ATM IP Address = 192.168.xxx.xxx or 10.xxx.xxx.xxx then these are 'private' IP address and therefore RMS cannot contact them remotely unless the RMS PC is in the same network.

To enable the RMS Schedule options, you must first enable RMS Send, and input the phone number or IP address of your RMS PC. Remember that for Internet communications you MUST have a publicly addressable IP address for your RMS computer so the ATMs can contact it. Talk to your internet provider or IT personal about how best to do this.

With RMS Send Enabled, you can now set the RMS Schedule Options

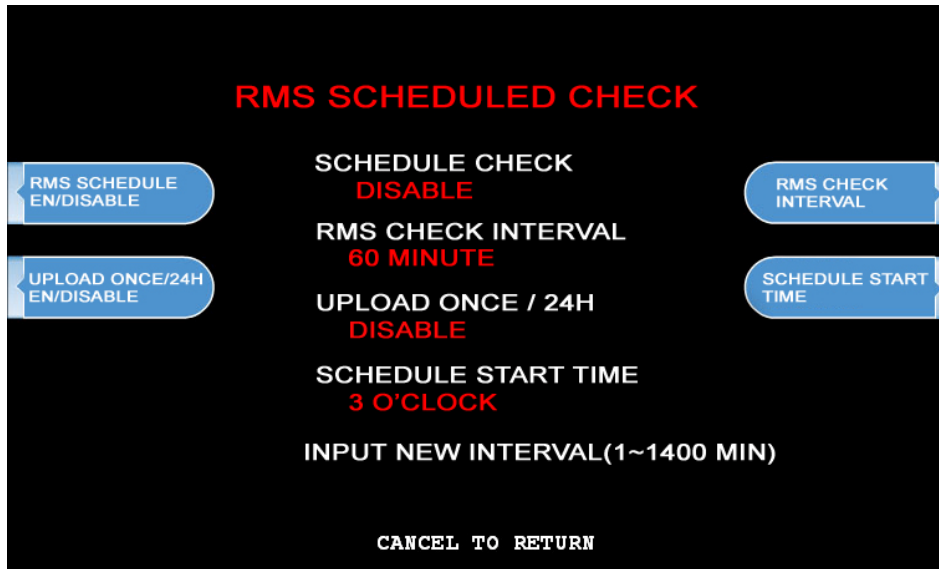

RMS Schedule: (Enable/Disable) this turns on and off the Schedule system.

RMS Check Interval: Enter a value in minutes, from 1 to 1400 (1400=23 hours)
This is how often the ATM will attempt to connect to you RMS PC and perform whichever tasks you specify in RMS. Note that if you set the value to 1 minute, the machine will attempt to connect to RMS every 60 seconds.

If the system is unable to connect with the RMS PC, then it will reattempt the call again. If that second attempt fails, then it will wait again until the next Check Interval before trying again (twice).

Upload Once / 24 Hours: When this is enabled, once the ATM can successfully connect to RMS and perform the preset tasks, then the ATM will not attempt to connect again for 24 hours.

If you set this to Disabled, then the ATM will continue to connect to the RMS PC at each Check Interval time

Schedule Start Time: The ATM will begin the counter for 'Check Interval' starting from this time.

RMS Send: Remember that the Schedule system is independent of RMS Send. Which means that if your ATM goes out of service, and is still hours away from the next Check Interval, the ATM will always send it's status alert via RMS Send. See page 3.11 for details on how RMS send works.

3.2.8 TRIAL DAY TOTAL

Trial Day Total feature allows the ATM to complete a Day Total operation (without actually closing out the machine) at a predetermined time each day. This is useful if you are doing accounting of your ATM on a day-to-day basis. Your processor cuts off its transactions each day at a set time. By enabling Trial Day Total at the same time, your day's balance should match the host. This information will appear as a journal record, so you will need to access your journal to print or view the totals. Your dealer or processor can provide you with the appropriate cut off time.

Trial Day Total Set	Enables or Disables the function
Change Time	Sets the time for the ATM to total itself

3.3 THE SYSTEM SETUP MENU

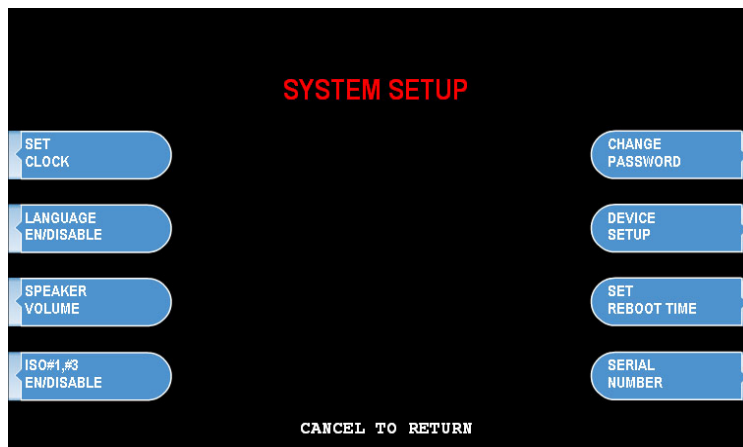

3.3.1 SET CLOCK

The Set Clock menu allows you to set the clock built into the ATM to the appropriate date and time. You should set this for local time in the area the machine is to be installed. Note that with each transaction you will see also see a “Host” time, this is the local time for the processor and may be different from local time at the ATM. To set the clock, simply press the Set Clock button and press the key corresponding to the function you want to set (month, day, year, etc.)

NOTE: The ATM will not automatically adjust for daylight savings time. You must set this manually if you wish it to change.

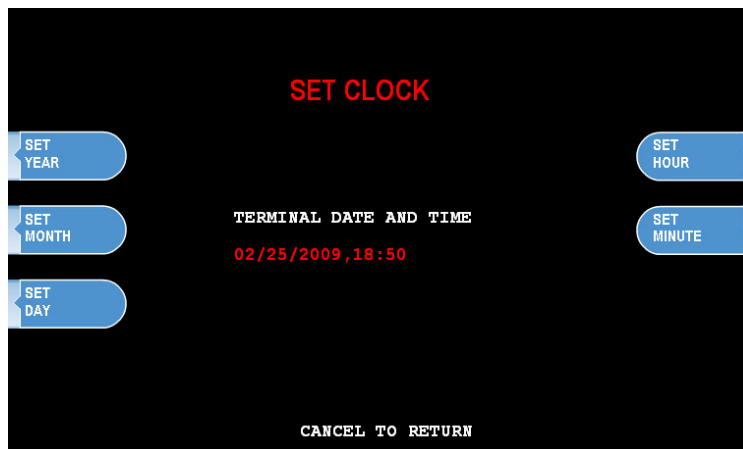

3.3.2 OPTIONAL LANGUAGES

The Genmega G2500™ ATM supports 4 on screen languages: English, French, Spanish and Korean. The optional languages will display on the welcome screen, then the customer will be prompted to choose a language to be used for the rest of that transaction.

NOTE: The optional languages are displayed on screen only and do not print on the receipt or journal. Receipts, journals and operator menus are always in English. To enable or disable a language, simply press the button next to the language you wish to change.

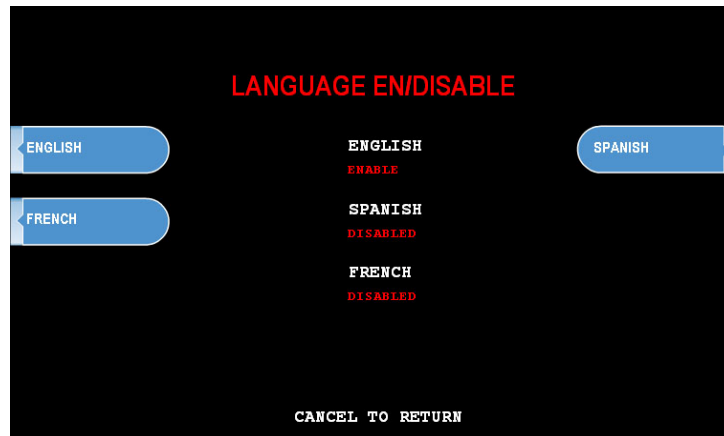

(Note: Korean language missing from above picture)

3.3.4 ISO 1, 3 EN/DISABLE

The ISO Tracks are the three tracks available for the card swipe head to read. The ATM is already defaulted to read from Track #2 (which is why it's not shown). This parameter should not be changed. Changing the ISO tracks can cause the ATM to not read cards properly.

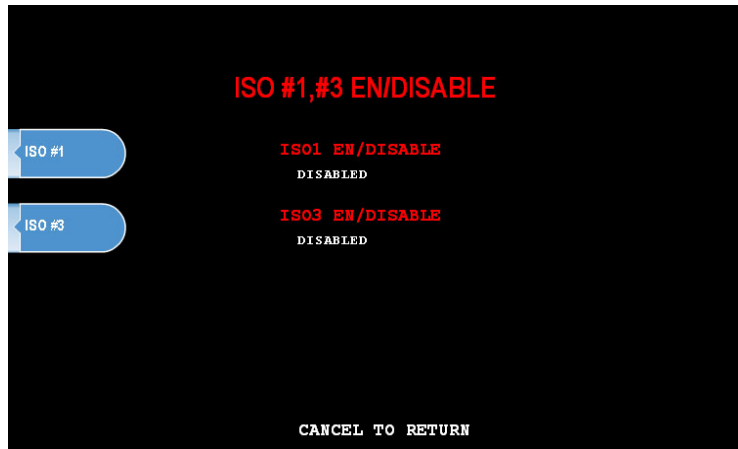

3.3.5 CHANGE PASSWORDS

The ATM uses three passwords to provide security to the operator menu system. These are Operator, Service and Master.

- Operator Password (allows access to basic menu structure)
- Service Password (allows access to basic and diagnostic menus)
- Master Password (allows access to all menus including setup parameters)

The operator password can be changed by anyone with the current operator password. The service and operator passwords can be changed by anyone with the service password. The master password can only be changed by someone with the current master password. Any password can be changed using the master password.

For example, if you have lost the operator or service password, you can use your master password to change them. Simply enter the master password when it requests the operator or service password and then enter the new password.

You are required to change the master password from default before the ATM can go in service.

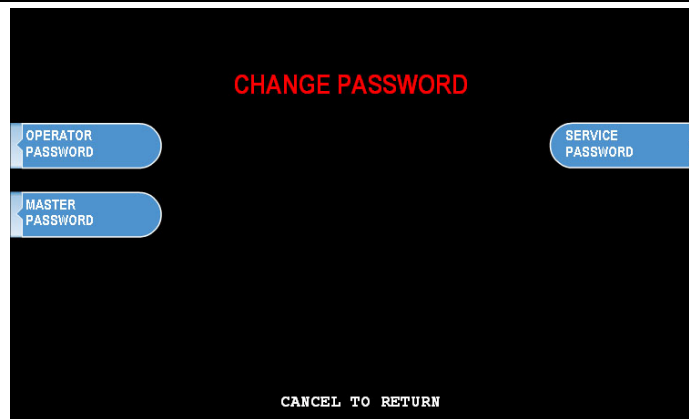

To change a password, press the button for the appropriate password. You will be prompted to enter the new password and then enter it a second time to verify. If you forget your password please contact your dealer or distributor for service.

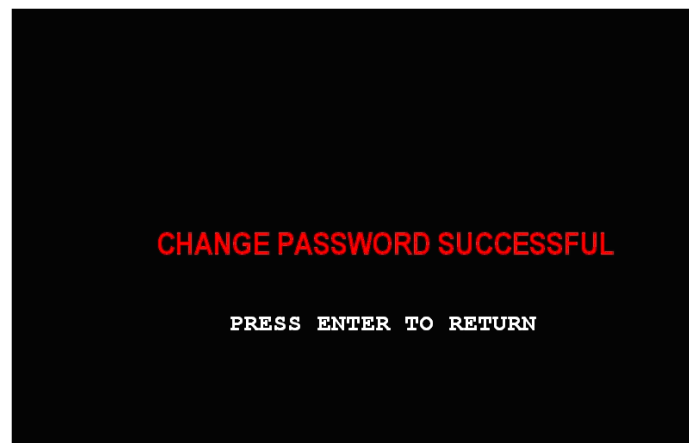

NOTE: All passwords MUST be 6 digits. If you use a password that is less than 6 digits, the passwords may default back to factory if the machine is power cycled. If your customer wants a 4 or 5 digit password, add zeros to the end to make it 6 digits.

WARNING: The ATM will NOT go into service with the default master password. You must change the master password from default! If you attempt to go in service with the default master password, you will receive a **F0016** Error, which will notify you that the master password has not been changed.

It is critical that you do not set the same password for each of the three levels. If you duplicate the password, the lower level permissions will be the default. For example, if the Operator Password is set to 123456 and you also set the Master Password to 123456, then when you log in with that password, you'll only have access to Operator level commands. In this example, you'd have to change the Operator Password to something else, and then 123456 would then allow you to log in as Master. If you forget the passwords, you'll need to reload the AP software to reset.

3.3.6 DEVICE SETUP

The Device Setup menu provides options to adjust parameters of the various peripherals. Under normal circumstances you should not need to make changes to these parameters. The default settings are optimized for your particular machine.

Genmega recommends only using these tools under the direction of an Authorized Service Provider (ASP) or Genmega Technical Support.

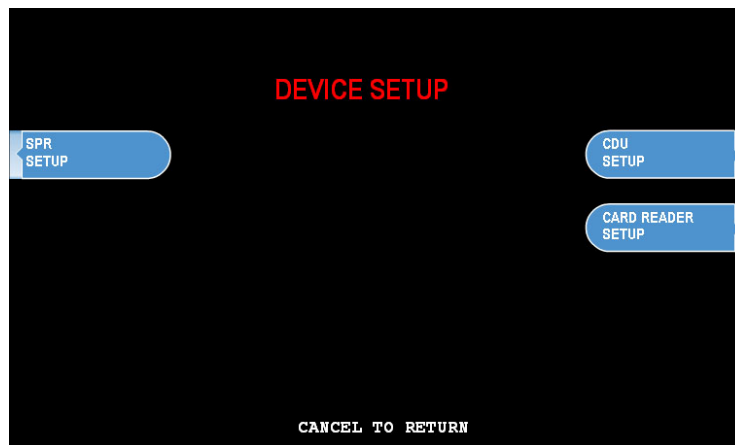

3.3.6.1 SPR SETUP

The SPR Setup allows you to set the maximum column width for the receipt printer. Default is 40 characters.

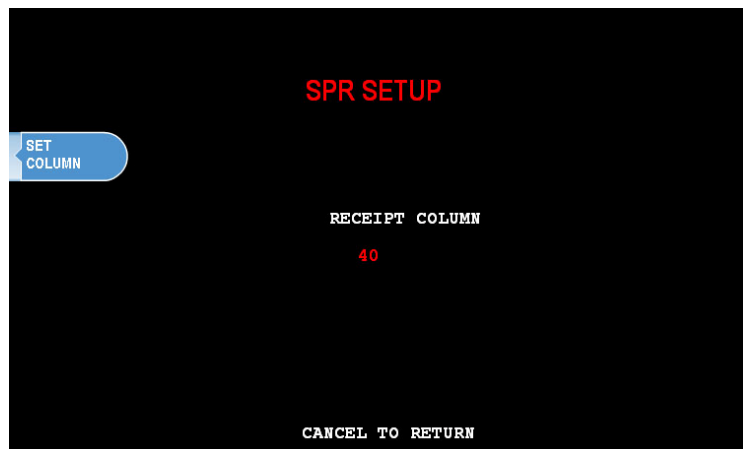

3.3.6.2 MODEM SETUP

The Genmega G2500™ series use an onboard 56K modem. The modem is preset at the factory for optimal use. Changing these settings can cause your machine to not communicate or may slow communication speeds. Do not make changes to the modem settings.

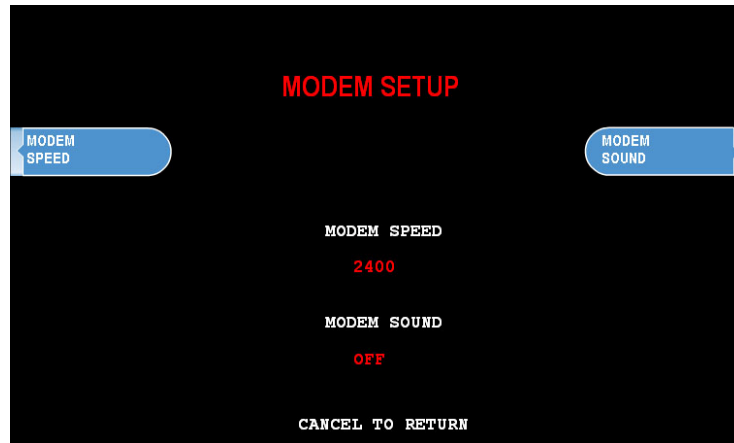

MODEM SPEED

This sets the speed at which the modem will begin communication with the host. The default speed is 2400. Most processors are only using 2400 baud modems, so setting this value higher may not increase modem performance.

Available settings : 1200, 2400

MODEM SOUND

This feature is not active on this machine, toggling the option from ON to OFF will have no effect.

3.3.6.3 ATM TCPIP SETUP

See page 3.34

3.3.6.4 MCR (Card Reader) SETUP

The Genmega G2500™ can be equipped with an optional EMV compliant card reader. If the setting is not correct, the card reader will not work at all. After setting the MCR to the appropriate type reader, back out of the menus and then reboot the machine for the changes to take effect. Since these different card readers use alternate ways to communicate, it's necessary to reboot.

3.3.6.5 CDU SETUP

The CDU (Cash Dispensing Unit) or Dispenser contains programming relative to its application and country of destination. This programming does not need to be altered, however in the event that the dispenser loses its factory programming the CDU Setup application can correct any problems. **NOTE:** Incorrect programming of the dispenser will cause the machine to go out of service.

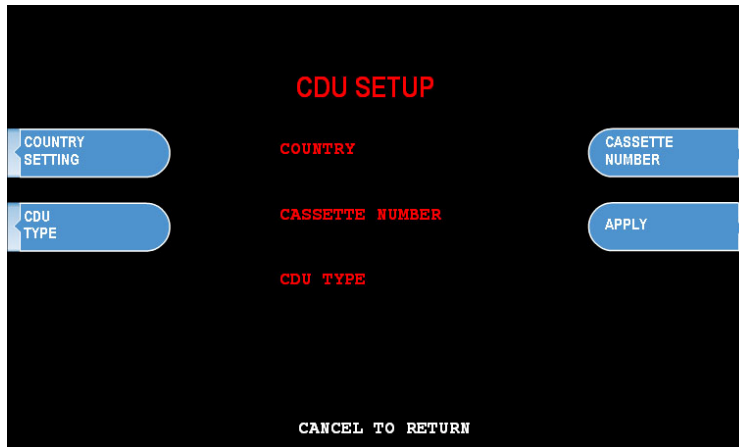

Country Setting: Set to USA or Canada

Cassette Number: Set to 1 or 2 depending on number of cassette

CDU Type:

CDU Model	Set CDU Type
TCDU / SCDU	Front Loader 1K
MCDU / HCDU	Front Loader 2K
Rear Load MCDU	Rear Loader 2K (*not available on G2500)
De La Rue	SDD with S/M
Teanam	GBM
Puloon	LCDM1000

Configuring Dispenser:

Once the settings are correct, then press 'Apply' to configure the dispenser. If you get the error 'No Comm' or CDNxx, it means that either the settings are incorrect for the dispenser type (for example if you try to program a SCDU as a De La Rue SDD, it will not work) or if there is a problem with the cables that connect the dispenser to the main control board.

Note: Installing different dispensers may require additional hardware, check with Support before installing if you are unsure.

3.3.7 SET REBOOT TIME

The G2500™ contains a feature which automatically reboots the machine at a 24 hour interval. By default this will occur at 03:00 am. This adjustable in 1 hour increments.



3.3.8 SERIAL NUMBER

The serial number is a unique number programmed into your machine at Genmega. It not only identifies your machine for warranty purposes, but also for remote monitoring using RMS. The first 4 digits refer to the model type, and the last 6 is production cycle. By default this number is programmed from the factory and we do not recommend changing it. However if you need to clear NVRAM for any purpose this number will be deleted. If you wish to re-enter the serial number, you'll find it on the sticker located inside of the upper cabinet.

For G2500 machines the number will begin with the prefix TYAH

Example = TYAH001234

Keeping the serial number in the proper format will prevent problems when trying to connect for remote management.

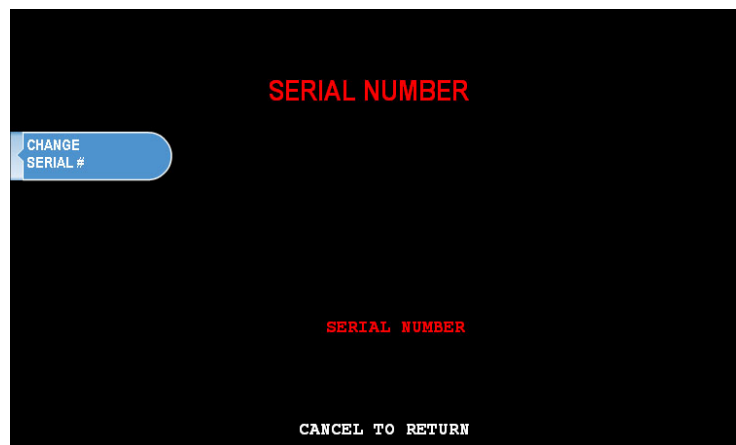

3.4 CUSTOMER SETUP MENU

The Customer Setup menu controls surcharge information, BIN lists, receipt options, advertisements and keypad lighting.

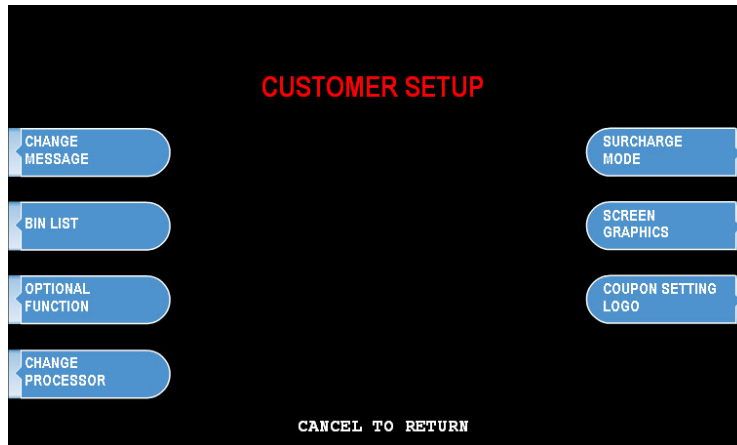

3.4.1 CHANGE MESSAGE

The Messaging options for the ATM are a welcome message and a receipt header message. The Welcome message allows line of 35 characters, which will appear at the top of the main screen (above the center graphic). The receipt header is up to 4 lines of 25 characters, which will appear at the top of each receipt.



WELCOME MESSAGE



Once you have selected Welcome Message from the Change Message Menu, you will be prompted with the following screen.

RECEIPT HEADER



Once you have selected Receipt Header from the Change Message Menu, you will be prompted with the following screen. See the above instructions for navigating this menu.

3.4.2 BIN LISTS

BIN numbers are card numbers that you have preset with your processor to not be surcharged. You must set this up with your processor, who will then give you numbers to enter in the list. These numbers will reference cards that you wish to not be charged a surcharge for transactions. The ATM will hold up to 60 numbers.

If you need more BIN numbers, there is a file that can be created to load several thousand more numbers. Contact technical support for instructions.

Step 1

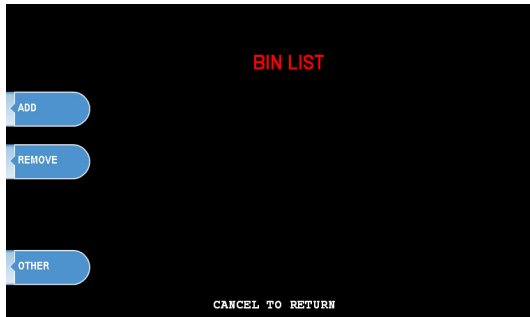

To enter the BIN numbers select BIN List from the Customer Setup menu. The list can hold 2 banks of 30 numbers for a total of 60. Bank 0 and Bank 1. Press the OTHER button to switch between the banks.

Step 2

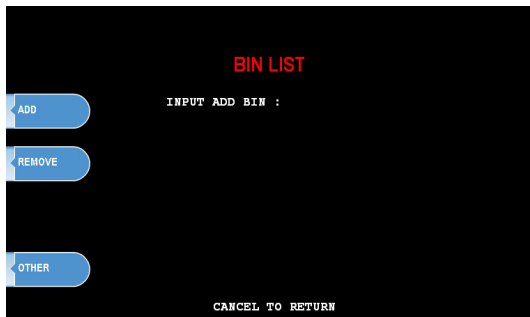

To add a number, press ADD and input the BIN number with the keypad. To remove, press REMOVE and type in the BIN number you wish to delete from the list.

Press OTHER to switch between Bank 0 and Bank 1.

Step 3

If you wish to view the contents of the BIN list, use the Print All Setup report. From the Operator Function Menu, go to Reports, then Print All Setup. Any numbers added to the BIN list will be visible from this report. **NOTE:** Numbers loaded via the extra BIN file will not display on the Print Setup or any other report.

3.4.3 OPTIONAL FEATURES

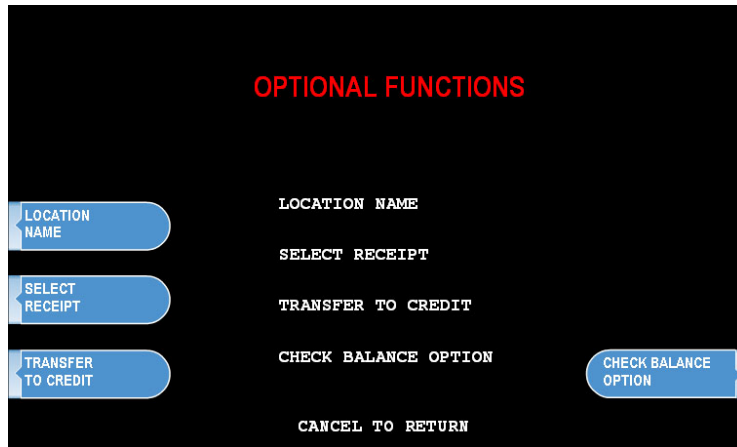

The G2500™ ATM offers several optional functions to improve performance and keep the ATM functional in the event of a paper problem (jam, out of paper etc.)

LOCATION NAME

Adding a name to this location will print the name entered onto the journal records and print all setup. This is purely a convenience option and is not required.

SELECT RECEIPT

This feature allows the ATM to complete transactions even though it may not be able to dispense a receipt. If the ATM experiences a paper jam, or runs out of paper, the customer will be asked if they would like to complete the transaction even though they will not receive a receipt. If the customer answers Yes, the transaction will continue. Following the transaction the customer's information (what would have appeared on the receipt) will display on the screen. The ATM will continue to operate without use of the printer until someone accesses the Operator Function menu. At that time the error must be corrected before the ATM will go back into service.

To enable the option, press Select Receipt, the lower portion of the screen will display the options status.

TRANSFER TO CREDIT

Some networks do not allow customers to transfer funds to or from their credit cards. By enabling / disabling this option you will add or remove the option button from the customer menus. Check with your Distributor / Processor as to whether or not they support fund transfer to or from credit cards. NOTE: If your network does not support such transfers and you leave the option enabled, the customer can choose it from the menu however the network will not authorize the transaction.

CHECK BALANCE

Enabling this option will ask each customer if they would like to check their balance before each transaction.

3.4.4 CHANGE PROCESSOR

Host Processor selection changes the communications protocol to specifically match your particular processor. In most cases this is set at the factory when your machine is ordered, however in the event that the machine needs to be reprogrammed for a new processor, it may be necessary to change the processor mode.

To access the Host Processor mode, enter the Customer Setup menu using the Master Password.

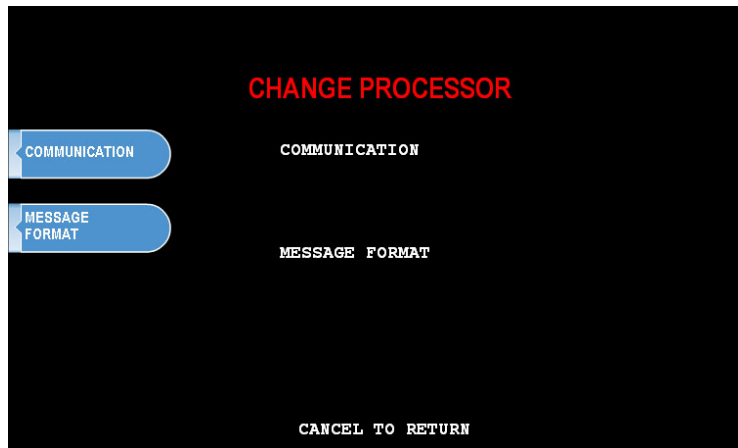

Communication modes are:

Modem – dial up (uses on board modem)

TCP/IP – Standard TCP/IP
 VISA FRAME TCPIP
 ACK CONTROLLED TCPIP
 SSL PASS THROUGH
 SSL LENGTH PREFIX W/O ETX
 SSL LENGTH PREFIX WITH ETX

**** See page 3.34 for TCP/IP Setup Instructions ****

Use the Message Format button to select the appropriate Host Processing Mode.

Available formats are:

Standard 1
 Standard 2 (CSP200 Emulation)
 Standard 3 (Extended Message)
 EPS

If Standard 3 is selected, you'll see a Standard 3 Options button which will give access to the Extended Messaging options.

Contact your distributor or processor for which mode is appropriate.

3.4.5 SURCHARGE MODE

The Surcharge menu displays the current rate at which customers are charged per transaction, the person or account that the surcharge funds are sent to and whether or not the option to surcharge is enabled or disabled. The information programmed here must match the information given to the processor at the time the account was created. Because of features like Percentage Surcharge that require the surcharge value to be set at the ATM, it's possible for the ATM to override what the processor expects to surcharge (or not surcharge customers at all) if these settings are not correct.

Please review the following setting carefully and instruct your operators on the risks involved in changing surcharge settings.

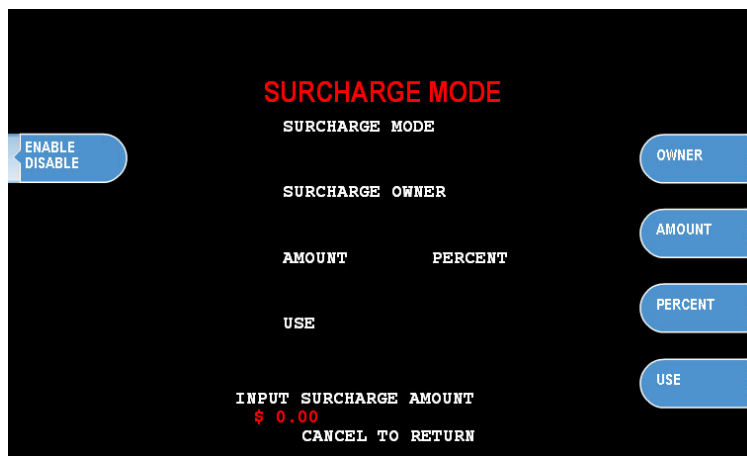

To set the surcharge parameters begin by entering the Surcharge Mode menu from the Customer Setup menu. The bottom of the screen displays the current status of each surcharge parameter.

DISABLE/ENABLE

This button toggles the surcharge option on and off.

AMOUNT

To set the surcharge amount, press the amount button and type the dollar amount using the main keypad. Next set the decimal point using the Enter key on the keypad. Then type the cents using the keypad and finally press Enter to finish.

PERCENT

This allows you to set the surcharge amount as a percentage of the overall amount the customer is withdrawing per transaction. Check with your processor to make sure that they support this function.

SURCHARGE OWNER

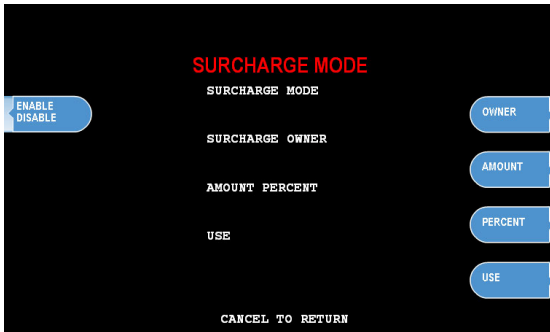

The surcharge owner can be up to 25 characters long. This owner name will appear at the bottom of each transaction receipt.

WARNING: If you set the percentage surcharge mode from 'Greater' to 'Lesser' and leave the percentage value at 0%, then customers will not be surcharged.

Example - Surcharge set as follows:

Surcharge \$1.50 or 0% whichever is 'Greater' = customer is charged \$1.50. Because \$1.50 is a greater value than 0.

Surcharge \$1.50 or 0% whichever is 'Lesser' = customer is not charged at all. 0% is lesser than \$1.50.

3.4.6 GRAPHICS

The Genmega G2500™ is capable of displaying up to 8 customized graphic screens. These graphic files are created on a computer and then downloaded into the ATM either directly at the ATM using a SDRAM card or by using the Genmega Remote Management Software (RMS). When the advertisements are loaded and enabled they will rotate in order while the ATM is waiting for a transaction and also while the transaction is processing. There is a timer, which allows you to set a delay before switching to the next graphic screen. Please see Appendix D at the end of this manual for detailed instructions for creating advertisements.

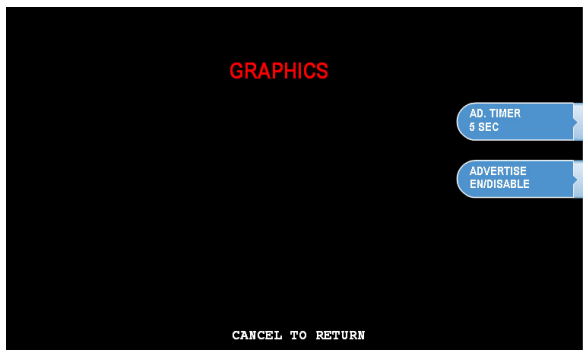

Step 1

Enter the Graphics menu and choose “Advertise” enable or disable each loaded graphic.

3.4.7 RECEIPT GRAPHICS

The Genmega G2500™ is available with an optional 3” printer which is capable of displaying a graphic on the receipt. (the standard 2” printer cannot display graphics)

This image will appear at the top of the receipt and is in addition to any receipt header message or coupon that you can add through the programming menus.

See the Appendix D section at the back of this manual for instructions on loading receipt graphics.

3.5 TRANSACTION SETUP

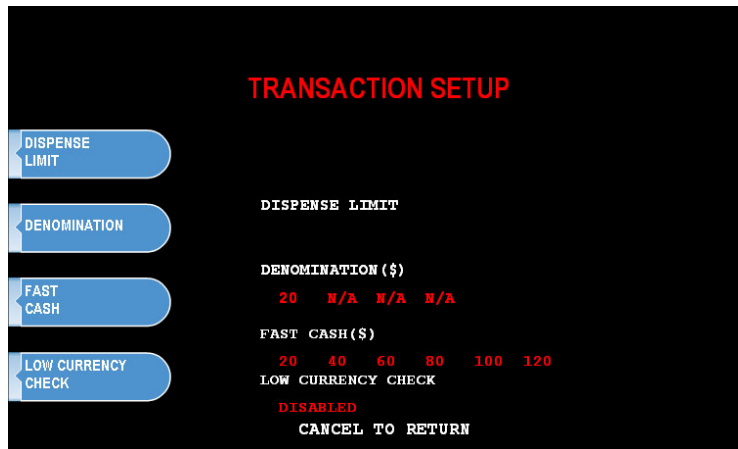

3.5.1 DISPENSE LIMIT

The dispense limit is the maximum amount of money a customer can withdraw in a single transaction. The ATM will dispense a maximum of 40 notes per transaction. So the dispense limit can be a maximum of 40 times the denomination of notes your using.

For example:

- If you are dispensing \$10 bills the maximum dispense limit is \$400
- If you are dispensing \$20 bills the maximum dispense limit is \$800
- Maximum is \$900 (using either \$50 or \$100 bills)

To set the dispense limit, press the Dispense limit button and then enter the number using the keys on the main keypad. Press Enter key to set the value.

3.5.2 DENOMINATION

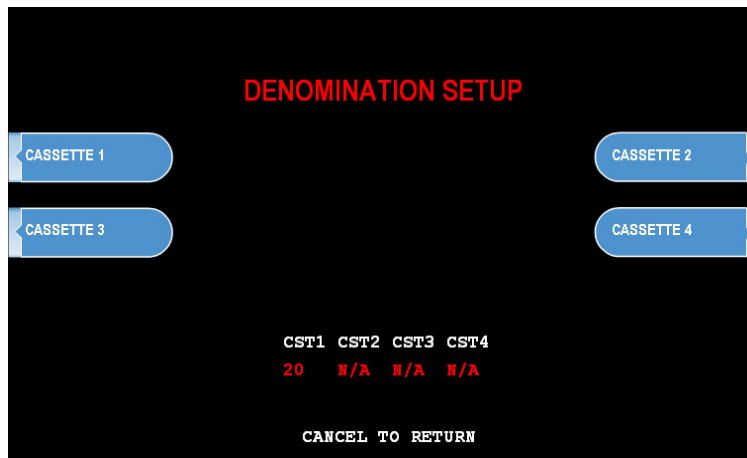

The Denomination is the type of bill that each cassette will be dispensing. The ATM offers a second cassette as an option. This second cassette can be programmed to dispense notes, it can also dispense a preset number of bill sized coupons with each transaction and finally it can dispense a “value coupon”, where you would set the value of the coupon and the customer could purchase this using their card.

WARNING: Any change to the denomination will cause all master keys to be deleted from the EPP keypad. If you attempt to enter the denomination setup menu, you will be prompted and warned that continuing will cause all master keys to be erased. The purpose of this is to prevent unauthorized changes to this critical setting.

When programming the ATM, make sure to make any changes to the denomination setting BEFORE you program master keys. Once keys are erased, they cannot be recovered. New master keys will have to be loaded.

When programming the ATM, make sure to make any changes to the denomination setting BEFORE you program master keys.

Once keys are erased, they cannot be recovered. New master keys will have to be loaded.

To set denomination on the first cassette, press the First CST Denomination button and then using the main keypad enter the type of bill. Options are \$1, \$5, \$10, \$50 and \$100.

To set denomination on the second cassette, press the Second CST Denomination button and then using the main keypad enter the type of bill. Options are \$1, \$5, \$10, \$50 and \$100.

3.5.3 FAST CASH

Fast Cash amounts are presented to the customer if they choose a Withdrawal transaction. These amounts appear on screen as an easy method of selecting how much cash they wish to withdraw for that transaction. The amounts must be multipliers of the denomination amount.

For Example:

- If your dispensing \$10 bills then you can use \$10, \$20, \$30, \$40, \$50 etc.
- If your dispensing \$20 bills then you can use \$20, \$40, \$60, \$80, \$100 etc.

To set the fast cash amounts, select Fast cash from the Transaction Setup menu and then choose from the 6 possible keys to program. Select a button and then enter the value from the main keypad. Press Enter to confirm the setting.

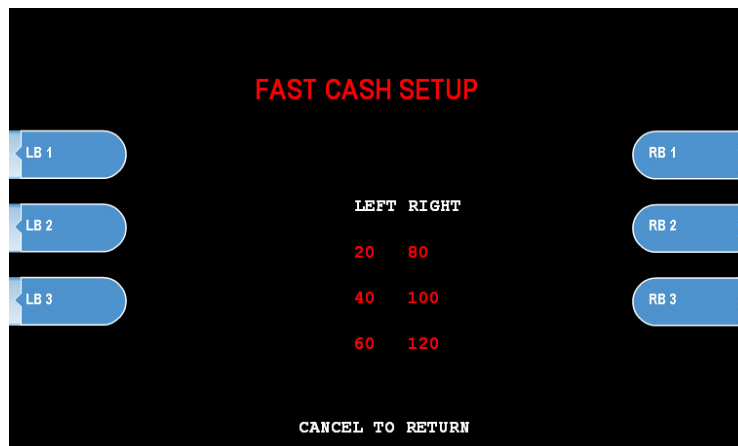

3.6 TCP/IP SETUP

TCP/IP Setup is done in several menus. First you need to specify TCPIP from the Communications Menu: [See page 3.27] Check with your processor for which protocol settings they are expecting.

To change, go to:

Operator Function Menu → Customer Setup → Change Processor → Communication
 Change this value to SSL PassThrough (or other depending on processor)

Once you change from Modem, to one of the TCP/IP settings, several other menus change to support various network functions.

For Example:

Operator Function Menu → Host Setup → Host IP and Port #

Here you will set the Host Processor IP (or URL) address and port. For some processors an IP address (example = 121.212.1.21) is used and for others you'll enter a URL address (example = trans.mybank.processor).

In addition to the address, there will also be a port setting (example = 6543)

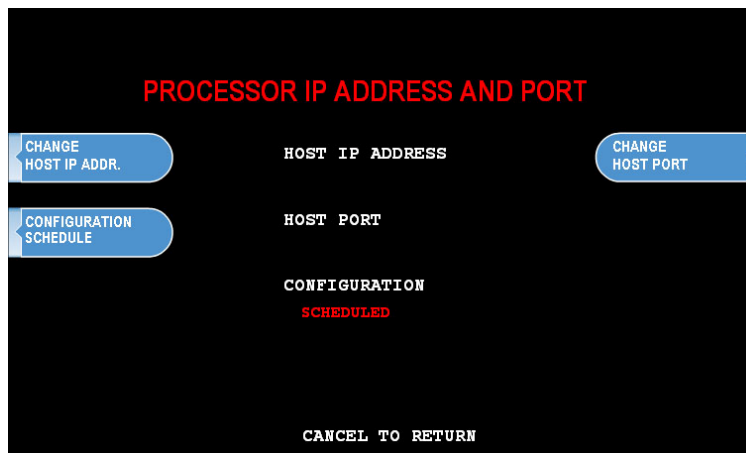

Configuration Schedule allows you to force the ATM to update configuration with the host upon boot up. You might use this command if the terminal gets consistent Key Errors and you want to force download of a new working key.

The ATM IP information is set using the menu found at:

Operator Function Menu → System Setup → Device Setup → ATM TCP Setup

This menu is only active if you have the communication mode set to TCP
 [See page 3.24]

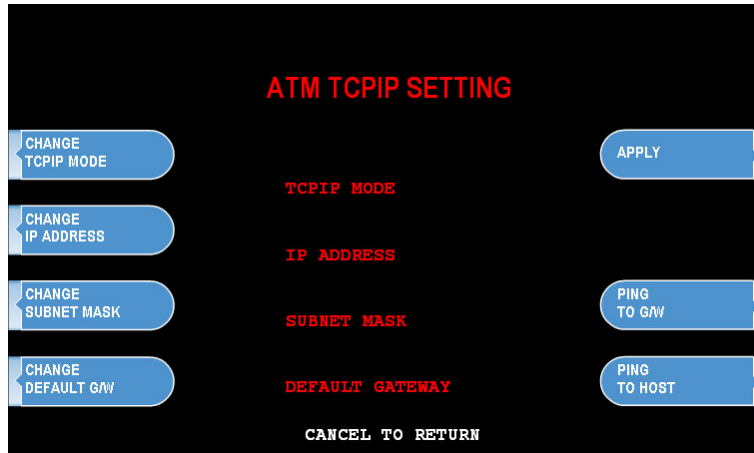

These settings will be dependant on the network connection available at the location where the ATM is deployed. It may be necessary to contact the ISP or Network provider for the location to determine how this should be set.

TCPIP Mode: DHCP or STATIC IP

NOTE: In almost all cases you will choose DHCP when setting up you machine on the internet. Uses for STATIC include ATMs on corporate networks (casino, hotel, store chain) or some wireless devices. Check with the locations IT staff, or the instructions provided with your wireless device for assistance.

In typical installations, for example a store or location with a DSL or broadband internet connection that you are tapping into, you will always use DHCP mode.

Change IP Address: Enter the ATM IP address here (for static IP) or this field will automatically populate if DHCP is used to obtain an IP automatically.

Subnet Mask and Gateway: These values will be provided by your ISP/Network Provider and refer to the Router that you'll be connecting to.

Ping to Gateway: This is a test which will 'ping' the Router and verify communication between the ATM and the network. If this test fails, then the ATM will not reach the host.

Ping to Host: This test attempts to verify communication with the IP address or URL that is programmed in the 'Processor IP Address' menu. Note that most processors or switches do not allow 'pinging' for security reasons.

TCPIP Troubleshooting

When trying to connect your ATM to the internet, there are two error codes which can occur.

2511 – This means that the ATM sent a request, however nothing responded. Typically this means the ATM cannot get out on the internet.

To test this, we suggest replacing the Host IP number with one from a common public website like Google [74.125.224.50] or Yahoo [98.137.149.56] Those 'public' IP addresses will allow ping. So after entering it, you can go to the 'Ping to Host' button in the TCPIP setup menu and check that you can ping Google or yahoo. If you are unable to ping those sites, the ATM cannot see the internet.

DSL Modems – some 'cheap' DSL modems will not allow the ATM to use DHCP and obtain an IP address, even though other computers or devices can. This is usually shown in the ATM TCPIP Setup Menu, where the Gateway value is 0.0.0.0. If this occurs, you will need to get a broadband router to place in between the ATM and the DSL modem. This will allow the ATM to get an IP address from the router, rather than the DSL modem.

2514 – This means that the ATM sent a message and received an unexpected or incorrect response. Typically this means that one or more settings on the ATM are incorrect and should be compared against what the processor is expecting.

Network Cable:

When you connect the internet (Ethernet) cable to the ATM you should see a steady link-light (green) on the and also a flashing data-light (amber) as shown below.

Make sure you use a network 'patch' cable and not a 'cross-over' cable.

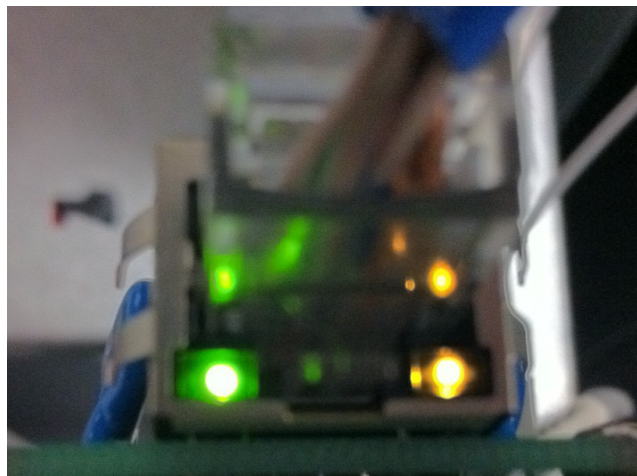

Also, there is a limit to how far you can run CAT-5 Ethernet cable, if your ATM is located more than 100 feet from the router, you may need to add a repeater to boost the signal.

OPERATION**4.1 OPENING AND CLOSING****4.1.1 Opening the Security Door****Step 1**

Turn the vault bezel key clockwise to open the lower vault bezel. The key will remain in the lock after you turn it.

**Step 2**

To unlock the Dial or optional Electronic Lock (see the manufacturers lock manual included in the open me first box for default combination) and then refer to Section 4.1.6 for lock instructions

**Step 3**

Turn the security Door Handle counter-clockwise; then pull the security door to open.

4.1.2 Closing the Security Door

**Step 1**

With the security door handle turned counter-clockwise, close the security door and turn the security door handle clockwise until it is locked. The electronic lock mechanism will lock itself once the T-handle has returned to its vertical position. The dial combination lock must be turned counter-clockwise to lock.

**Step 2**

Check the T-handle to make sure the lock has locked itself.

**Step 3**

With the security cover key turned clockwise, close the security cover and turn the security cover key counter-clockwise until locked. Remove the key when it is locked.

4.1.3 Opening the top Bezel

**Step 1**

The upper bezel lock on the Genmega G2500™ is located on the back side of the top of the machine. Insert the Bezel key and turn it clockwise to open.

(Optional Topper Shown)

**Step 2**

With the Front Panel key turned, pull the Front Panel outward.

4.1.4 Closing the top Bezel



Step 1

Push the Front Panel slowly until it is against the lock mechanism. Note: you must unlock the top bezel lock before the bezel will close all the way.

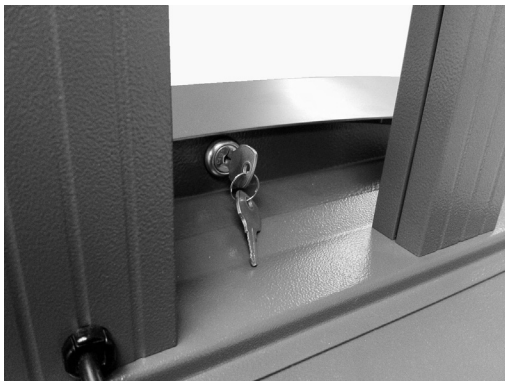

Step 2

To lock the top bezel, turn the Bezel key counter-clockwise until the key can be removed.

(Optional Topper Shown)

4.1.5 Operating and Changing the Combination Lock (non-electronic)

Before operating the lock or changing the combination, READ THE INSTRUCTIONS THOROUGHLY.

At the top of the dial ring, an index is provided for normal dialing and opening. At the side of the opening index (11 o'clock), a changing index is provided for use only when setting a new combination.

This is a precision lock; therefore, extreme care must be used to align the combination number with the index.

Turn the dial slowly and steadily. If after turning the correct number of revolutions, any number is turned beyond the index, the entire series of combination numbers must be re-dialed. **DO NOT TURN BACK TO REGAIN A PROPER ALIGNMENT WITH THE NUMBERS.** Each time a selected number is aligned with the opening index, a revolution is counted.

Please contact your distributor or consult manufacturers lock manual for default lock combination



Step 1

Turn the dial to the LEFT, stopping when the first number is aligned with the opening index, the FOURTH time.

Step 2

Turn the dial to the RIGHT, stopping when the second number is aligned with the opening index, the THIRD time.

Step 3

Turn the dial to the LEFT, stopping when the third number is aligned with the opening index, the SECOND time.

Step 4

Turn the dial slowly to the RIGHT until the bolt retracts.

TO LOCK

Turn dial to the LEFT at least four full revolutions.

!!! WARNING !!!

Before closing the vault door, try the new combination several times using the opening index.

Changing to a New Combination

To make up a new combination, select 3 sets of numbers of your own choosing.

- DO NOT USE NUMBERS BETWEEN 0 AND 20 FOR YOUR LAST NUMBER
- DO NOT USE NUMBERS ENDING IN 0 OR 5
- DO NOT USE NUMBERS IN A RISING OR FALLING SEQUENCE (e.g. 35-50-75)

Insert Figures (3)

Step 1

Using the changing index, dial the existing combination as explained in paragraphs 1-3 above.

Step 2

Hold the dial with the last number at the changing index and insert the changing key in the keyhole in the back of the lock. Insert the key until the wing is entirely inside the lock and comes to a positive stop.

Step 3

Turn the key one-quarter turn to the RIGHT or “clockwise”. With the changing key in this position, turn the dial to the LEFT; stopping when the first number of the newly selected combination aligns with the changing index the FOURTH time.

Step 4

Turn the dial to the RIGHT, stopping when the second number is aligned with the changing index, the THIRD time.

Step 5

Turn the dial to the LEFT, stopping when the third number is aligned with the changing index, the SECOND time. Holding the dial in this position, turn the changing key back to the LEFT or “counter-clockwise” and remove it. The new combination you have chosen is now set in the lock.

WARNING: NEVER INSERT THE CHANGING KEY IN THE LOCK WHEN THE COVER IS REMOVED. ALWAYS BE CERTAIN THAT THE WING OF THE CHANGING KEY IS ENTIRELY WITHIN THE LOCK BEFORE TURNING THE KEY. IF AN ERROR HAS BEEN MADE IN SETTING A NEW COMBINATION, WE SUGGEST THAT AN ACCREDITED LOCKSMITH BE CONTACTED.

4.1.6 Operating and Changing the Electronic Lock

Before operating the lock or changing the combination, READ THE INSTRUCTIONS THOROUGHLY*.

***See manufacturers lock manual included in the “Open Me First Box”**

The LA GARD “LG Basic” series electronic lock uses a touch key pad for all lock functions.

Power is supplied to the lock via a standard 9-volt Alkaline battery which contained within the external portion of the lock. The lock will warn of low voltage by repeatedly beeping.



TO UNLOCK FROM DEFAULT COMBINATION

Step 1

Press the default combination one button at a time, (see lock manual or consult your dealer for default combination). A beep is heard following each key press.

Step 2

If the combination is entered correctly a double-beep is heard and the internal lock solenoid will click indicating that the lock is open and the vault handle may now turn.

Step 3

If the wrong combination is entered a triple-beep will be heard. If the correct combination is not entered within 4 consecutive attempts a 5 minute delay or “lock out” will begin. During this time, the led at the 2 o'clock position on the face of the lock will flash at 10 second intervals. In addition any key press will respond with a triple-beep. Once the 5 minutes has elapsed, 2 more consecutive failed attempts will restart the 5 minute timer.

WARNING: While orienting yourself with the lock, making changes to the lock programming (including changing the combination) ALWAYS work with the vault door open. Do not close the vault until the lock has been thoroughly tested.

Genmega does NOT program a master combination!

Changing to a New Combination

NOTE: Combination is required to be 6 digits. Combinations of less than 6 digits will not work.

Step 1

Begin by entering six zeros. (000000)

Step 2

Enter the existing combination one time

Step 3

Enter the new combination twice. As each six digit sequence is entered, a beep is heard.

Step 4

If the procedure is not performed correctly, at the end a triple-beep is heard and the lock will revert back to the previous combination.

The LG Basic series lock includes several options including multiple user / manager passwords. Please consult the LA Gard manual included in the "Open Me First" box for instructions.

4.2 CASH OPERATIONS

4.2.1 Adding Cash to the Cassette (TCDU)

**Step 1**

Open the Security Door. (Please see 4.1.1 OPENING/CLOSING THE SECURITY DOOR.)

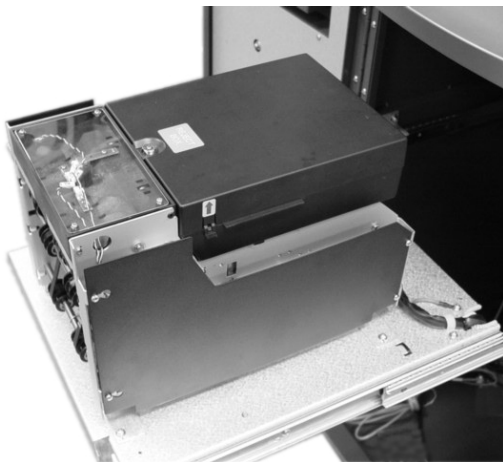
**Step 2**

For Genmega G2500™ with a fixed cassette dispenser (TCDU) use the following steps. For machines equipped with the removable cassette dispenser (SCDU or MCDU) please continue to Section 4.2.3.

With the security door open, remove the slide tray screw and slide the dispenser all the way out.

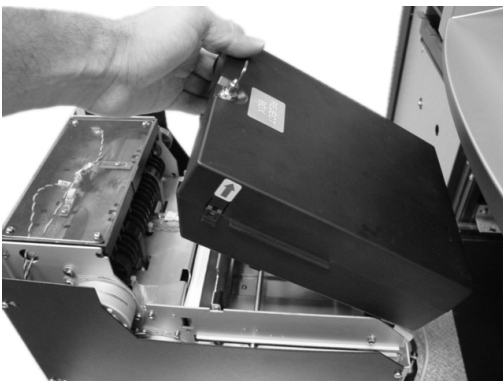
**Step 3**

Insert the key into the top of the reject bin and lift up to access the cash tray.

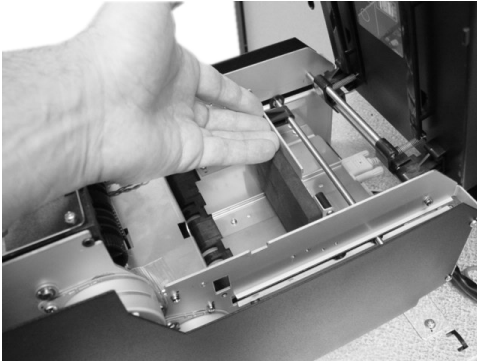
**Step 4**

Push the slide the push plate located inside the cash tray back (towards the rear of the dispenser) until it latches in place.

**Step 5**

Press on the latch bar to release the push plate against the notes.

TIPS ABOUT ADDING BILLS:

1. Fan the notes so that the notes are not sticking together.
2. Remove all the notes with holes or notes that are torn.
3. Unfold the folded notes.
4. Place all the notes correctly.

4.2.2 Emptying the Reject Bin



Step 1

Insert the key into the reject bin lock and turn to unlock.



Step 2

Pry back on the plastic tabs at the base of the arrow stickers on each side of the reject bin. Lift the reject bin lid.

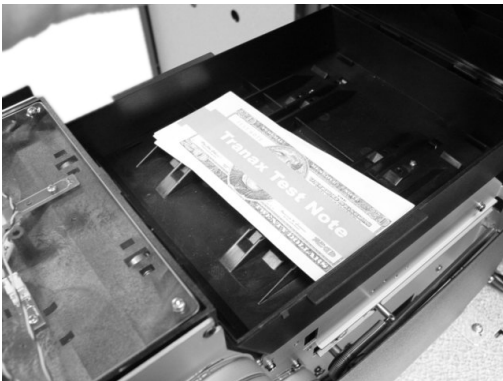

Step 3

With the reject bin open, remove any notes and then close the top. Turn the key to lock the reject bin in place.

4.2.3 Adding Cash to the Cassette (SCDU or MCDU)

**Step 1**

Open the Security Door. (Please see 4.1.1 OPENING/CLOSING THE SECURITY DOOR.)

**Step 2**

With the security door open, remove the cassette. Lift up on the handle while supporting the bottom of the cassette while removing.

**Step 3**

To avoid damage, never use force while removing or installing the cassette. If anything beyond gentle force is required while handling the cassette, contact your service personal.

**Step 4**

Open the cassette using the key shown in Section 2 (page 2.2)

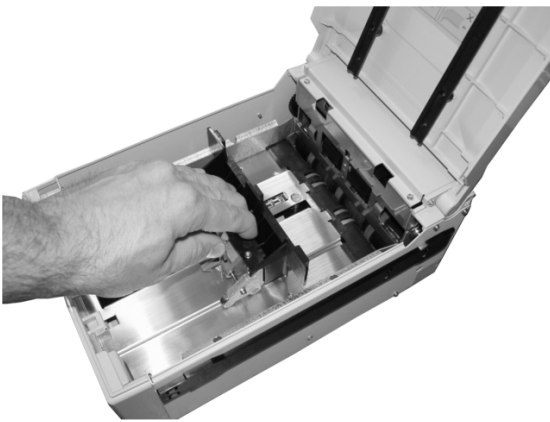
**Step 5**

Pull back on the cash plate and load the bills against the rollers at the back of the cassette. If you pull the cash plate back all the way it will lock at the front of the cassette. Push the green lever on the cash tray to release.

TIPS ABOUT ADDING BILLS:

5. Fan the notes so that the notes are not sticking together.
6. Remove all the notes with holes or notes that are torn.
7. Unfold the folded notes.
8. Place all the notes correctly.

4.2.4 Emptying the Reject Bin

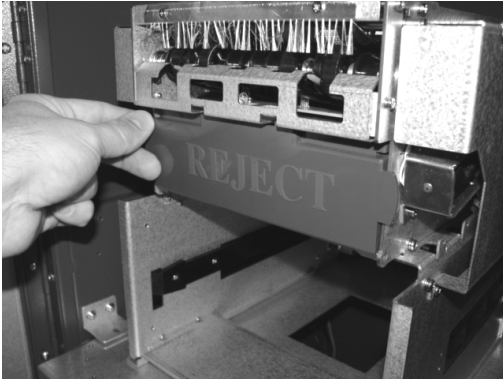
**Step 1**

To open the reject bin, pull back on the tabs located on the sides of the reject bin door.

**Step 2**

Remove any notes found in the reject bin and close the door by pressing it shut. Remember to include the number of bills found in the reject bin when settling the cassette.

4.2.5 Loading the Receipt Paper



Step 1

Open the top Bezel. (See 4.1.4 Opening the top Bezel.)

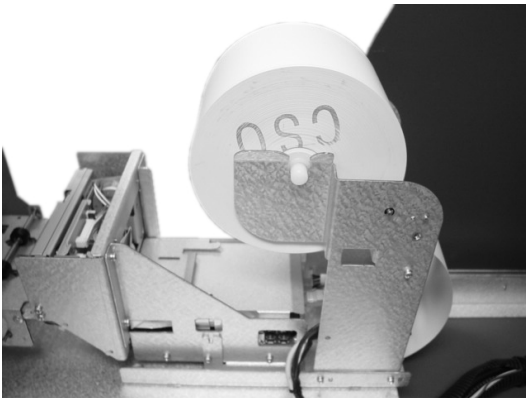

Step 2

Place the paper onto the supplied spindle with the Coated Side Out as shown in the picture. Feed the paper out through the back, where it will curl back under the tension bar.

Step 3

Prepare the new paper roll. Note below.

NOTE:

1. Make sure the roll is in its proper roll form. (A deformed roll may cause jamming problems.)
2. When replacing the new roll, make sure the end of the roll paper is clean cut.

**Step 4**

Feed the paper over the bar behind the roll and under the spring loaded tension bar. Slide the paper through the guides. The paper will not feed until the machine is initialized (powered on). If the paper does not feed, make sure the paper is all the way in the loading guide. Also make sure the roller assembly is closed (see below)

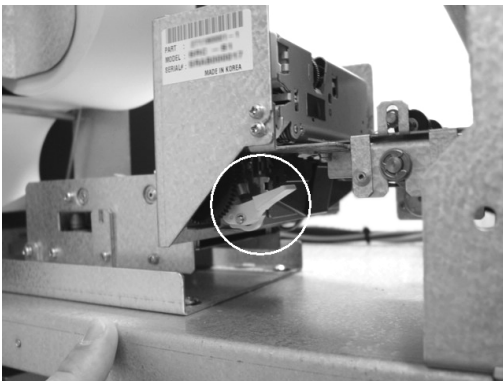
**Step 5**

The roller assembly can be opened by pressing down on the green lever in front of the printer.

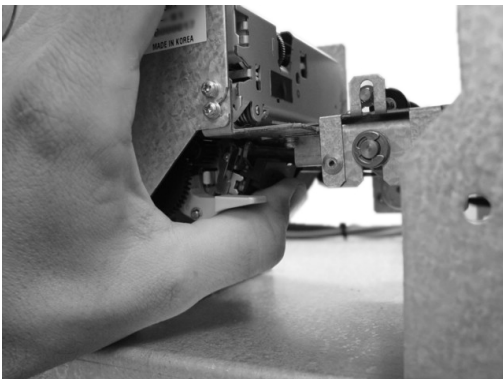
**Step 6**

To close the roller assembly, lift up on the rollers. The roller assembly must be completely closed before the printer will operate. Press up on the roller assembly rather than on the green lever to close.

When finished loading paper, close the top bezel and remove the key.

4.3 SETTLEMENT MENU

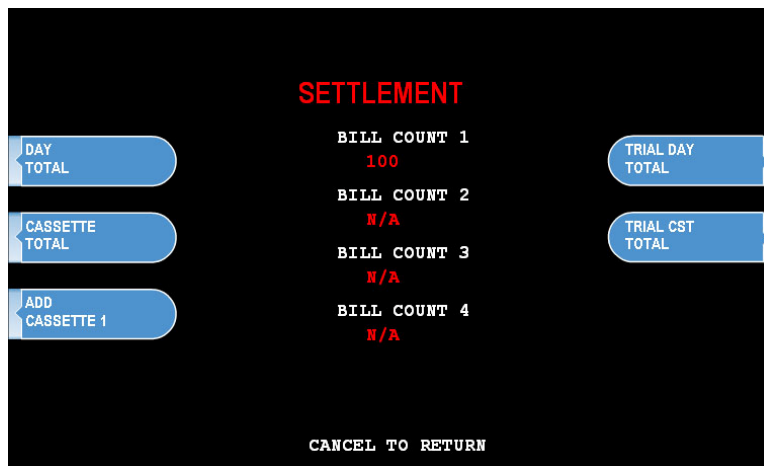

Choose Settlement from the Operator Function menu. This menu controls how many bills have been added to the ATM as well as generating Day total and Cassette total reports.

ADDING CASH

Step 1

Press the Add Cassette button.

Step 2

Using the main keypad, enter the number of bills added to the cassette (not the amount of money).

Step 3

Press the enter key when finished to set the amount.

If you make a mistake and wish to zero out the current number of bills, you'll need to press Cassette total to do this. Anytime you press Add Cassette you will be adding on to the current number of bills already programmed.

For example:

There are 50 bills in the cassette and in the settlement menu it says Current # of Bills = 50. You wish to add 25 more bills to the same cassette, you press Add Cassette, then type 25 from the keypad and press enter. The current number of bills will now be 75.

Now say there are 50 bills in the cassette and in the settlement menu it says Current # of Bills = 50. If you wish to remove 25 bills from the cassette, press Cassette Total. This will return the number of bills in both cassettes to zero and print a receipt showing remaining bills and loaded bills. Now press Add Cassette and enter 25 from the keypad, press enter to set. The current number of bills will now be 25.

DAY TOTAL

```

*****  DAY TOTAL  *****
=====
Start      : 01/01/2009, 05:34:08
Today     : 01/05/2009, 07:18:52
TERMINAL # 12345678

( TERMINAL TOTALS )
Count of Withdrawal : 0
Count of Balance    : 0
Count of Transfer   : 0
Count of Non-Cash   : 0
Amount of Dispense  : $0.00
Amount of Non-Cash  : $0.00
Amount of Surcharge : $0.00

( HOST TOTALS )
Count of Withdrawal : 0
Count of Balance    : 0
Count of Transfer   : 0
Count of Non-Cash   : 0
Amount of Dispense  : $0.00
Amount of Non-Cash  : $0.00
Amount of Surcharge : $0.00
    
```

The Day Total function keeps a running total of the ATMs transaction activity. When you press day total, the ATM will print a report showing transaction totals starting from the last time a day total was done until now. At the same time, the G2500 will dial into the Host Processor and retrieve their totals for the same time period. To the left is an example of a Day Total Report. Once the report is printed, the ATM will reset these values to 0 and begin recording from this point.

One thing to keep in mind when doing a Day Total is that the Host (or Processor) cuts off their transactions at a certain time every day. If you do a Day Total report before or after the processor has done their cut off, you may see discrepancies between what the terminal had reported and what the host reports.

To avoid this, talk to your dealer and find the approximate cut off time for your processor. Try to do your day totals at this same time. Remember that if you do not match your processor, the missing transaction(s) will usually appear on the next total. If you are unable to do your Day Total at the same time each day you can program the machine to do a "Trial Day Total" automatically (see section 3.2.7).

After the Day Total has printed you will be prompted on the screen that the total has printed and to press the Enter key to return to the menu.

CASSETTE TOTAL

```
*** CASSETTE TOTAL ***
Start   : 01/01/2009, 05:34:08
Today   : 01/05/2009, 07:18:52
TERMINAL # 12345678
CST1 Loaded   : 100($20)
    Dispensed : 0
    Rejected  : 0
    Tested    : 0
    Remaining : 100($2000)
CST2 Loaded   : 0(N/A)
    Dispensed : 0
    Rejected  : 0
    Tested    : 0
    Remaining : 0(N/A)
CST3 Loaded   : 0(N/A)
    Dispensed : 0
    Rejected  : 0
    Tested    : 0
    Remaining : 0(N/A)
CST4 Loaded   : 0(N/A)
    Dispensed : 0
    Rejected  : 0
    Tested    : 0
    Remaining : 0(N/A)
```

The Cassette Total function prints a report detailing the number of bills that have been loaded into the cassette and how many bills were dispensed, either to the customer, the reject bin or used during a dispenser test. This report will show totals from the last time you ran a Cassette Total to the current date. After the Cassette Total has been printed, all the values will reset to zero.

NOTE: Running a Cassette Total is the only way to clear the Settlement value back to zero bills. After the Cassette Total has printed you will be prompted on the screen that the total has printed and to press the Enter key to return to the menu.

TRIAL CASSETTE TOTAL / TRIAL DAY TOTAL

These reports are identical to pressing Day Total or Cassette Total, the only difference being that they will not zero out the amounts. This report is useful if you wish to know current Total statistics without closing them out. To run these reports, simply press the button and the report will print. Press Enter when finished to return to the Settlement Menu.

NOTE: Trial Day Total can be set to process automatically at a preset time. See Section 3.2.7 for information on automated scheduling of a Trial Day Total.

4.4 JOURNAL MENU

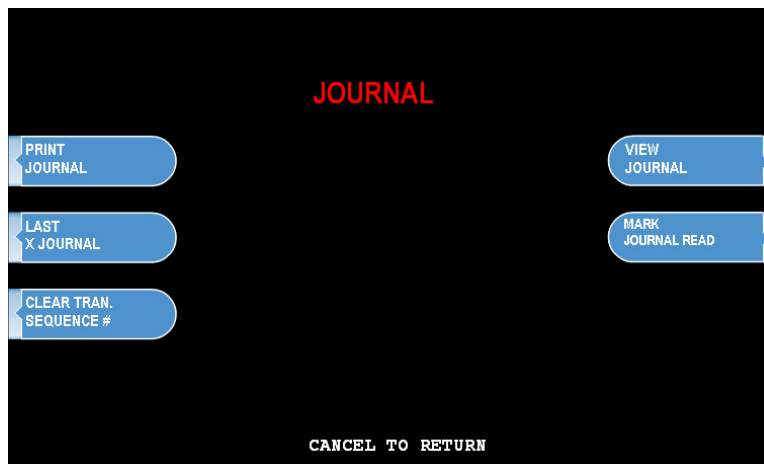

The Journal is an electronic record of all transactions, errors and some programming changes made to the ATM. Depending on the size of each entry, the memory can hold up to 40000 records. Each entry into the journal is indexed with a 5-digit sequence number starting with <00000>. Once the journal memory has reached its maximum limit, it will begin to overwrite the oldest entries. You will not be warned of this, therefore it is critical to make sure to download or print your journal often enough to avoid losing records.

The journal can be printed from the ATM in two different methods, Standard and Condensed. Standard will give complete information for each transaction (basically a copy of the customers receipt), whereas the condensed print will only show sequence number, date, time, what type of transaction and then amount requested / amount dispensed (in case of withdrawal).

PRINT JOURNAL

Step 1

To print the journal, press the Print Journal button.

Step 2

You will be prompted to choose standard (PRINT) or condensed (CONDENSED PRINT).

Step 3

The ATM will then print all journals in memory up to the last time you printed a journal. Each time you print a journal a marker is set at that point. The next time you print the journal, the ATM will print from that marker to the current time.

LAST X PRINT

The Last X Print option allows you to bypass the marker set when printing a journal and go back to recover an older record (so long as the record still exists in memory). For example, you print a journal and it includes sequence numbers <00001> to <00100>. If you wanted to go back and reprint journal number <00080> you would need to do a Last X Print for 20 records (100-20=80) this would give you records 100-80. To do a Last X Print, press the button and then enter a value of how many records you wish to go back.

CLEAR TRANSACTION SEQUENCE NUMBER

This function will reset the journal sequence number back to <00000>. This may be useful if you switch processing or switch Terminal ID numbers and want to keep new records.

VIEW JOURNAL

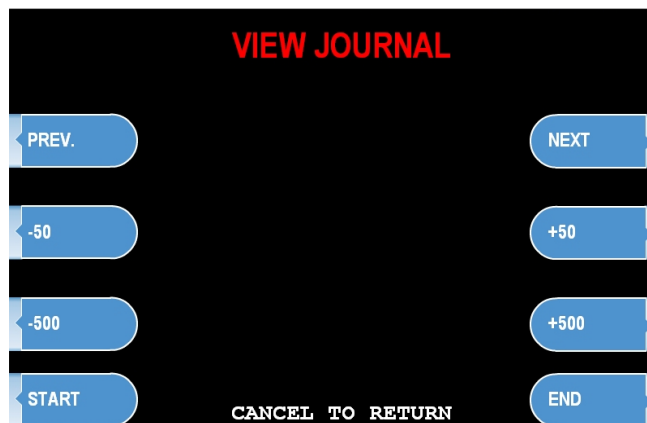

View Journal allows you to visually inspect the journal records. Press the View Journal button and you will see the screen to the left.

Use the Arrow keys on the main keypad to scroll through the records. You can also use the buttons next to +50 and -50 to go forward or backwards 50 records at a time. Use the Enter button to print the journal entry currently displayed. Press Cancel to exit this menu.

CLEAR JOURNAL

Clear Journal sets the current journal marker to the most recent journal recorded. It does not delete the journal from memory. For example: You currently have 100 entries in your journal, you press Clear Journal. Now if you press Print Journal, nothing will happen because there are no current journal entries, however if you used Last X Journal, you could enter 100 and get all the records.

COPY JOURNAL TO EXTERNAL DEVICE (USB / SD)

This option allows you to copy the contents of your electronic journal to an external memory device including a USB Drive or SD Memory Card. To copy the journal, insert the memory device in the socket located behind the LCD screen (top edge) and then press the button in the journal menu which corresponds with the type of memory device being used. To read this journal, you'll need to download a free utility from the Genmega website (or request from your ATM distributor).

This utility will allow you read / sort and print entries from the journal that was recovered from the ATM. The file that is saved on your memory device is named after the Serial number programmed at the terminal, so you can pull the journal from several ATMs onto the same memory device without worry of overwriting. **Note that it can take several minutes to copy the journal depending on how many records are stored in the ATM. So be patient when waiting for the files to copy.**

4.5 REPORTS MENU

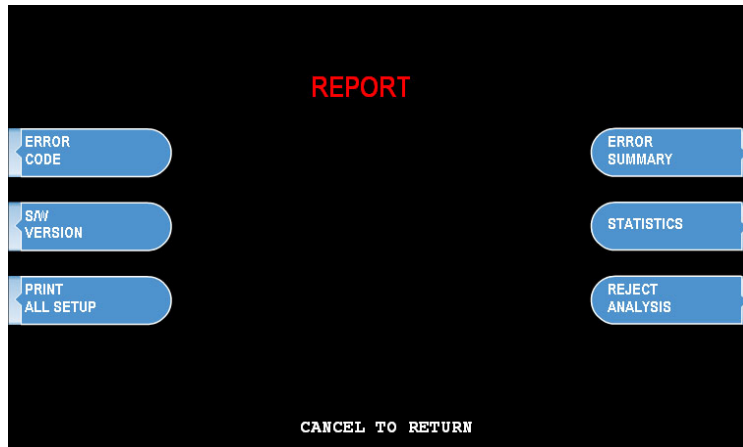

The reports menu provides statistical information as well as troubleshooting and error information.

ERROR CODE

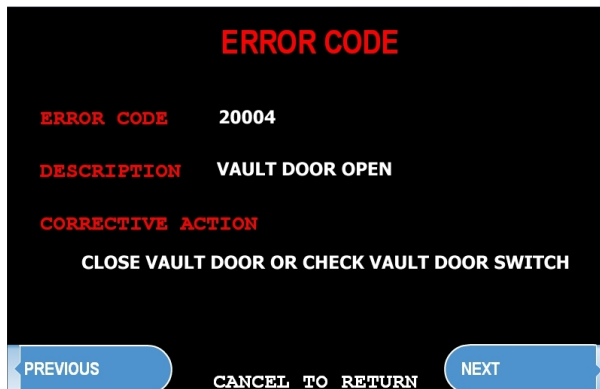

If the machine is out of service, and you are unfamiliar with the error code being displayed (or none is displayed), this screen will provide error descriptions as well as corrective action for the currently displayed code. Press the Error Code button to enter this screen. You can also use your left and right arrow keys on the main keypad to scroll through all the possible error codes and descriptions the ATM can report. To the left is an example of an Error Code screen.

S/W VERSION

This screen provides the current revisions of software used in your ATM. This information may be used to troubleshoot a problem, or simply to make sure that the software being used is up to date. It is useful to have this information when reporting a problem to your dealer / distributor. Occasionally check with your dealer / distributor for software updates. Press the S/W Version button to view the current revisions. Press Enter key to print a copy of the displayed information.

PRINT ALL SETUP

The Print All Setup report is a complete listing of all the programming details for your ATM. It includes everything from software versions to message screens and host setup parameters. This report is extremely important when troubleshooting problems. It is highly recommended to keep a copy of this on hand for when you need to contact your service personal. To print the report, press the Print All Setup button, when the report is finished it will prompt you to press Enter to return to the Reports Menu.

ERROR SUMMARY

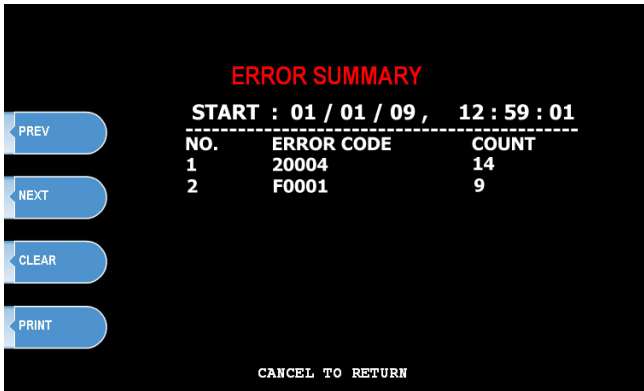

This report is a running total of all errors that have occurred to your ATM. It lists the errors by the number of times they occurred. Sometimes your machine can go out of service and no error code is displayed (usually with communications problems). If this happens, check the error summary, as the code will be displayed here. You can print these errors. To the left is a sample of an error summary report.

Press Clear to clear the report and start over. This can be useful if you have a machine where multiple errors are occurring. If you clear the error codes and then attempt a transaction, if that transaction fails, the error summary will only show those errors that occurred during that last transaction. You can also print the error summary list by pressing the Print button.

STATISTICS

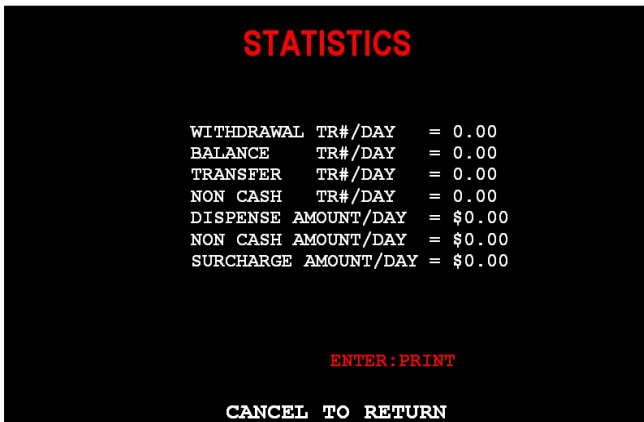

This report keeps running averages of transaction information, including:

- Withdrawal Transactions per day
- Non-Cash withdrawals per day (if enabled)
- Balance Transactions per day
- Transfer Transactions per day
- Notes Dispensed per day
- Surcharge amount collected per day

DIAGNOSTICS

5.1 DIAGNOSTICS MENU

The ATM features built-in diagnostics features to assist you in troubleshooting any problems that may develop. Below is the main diagnostics menu.

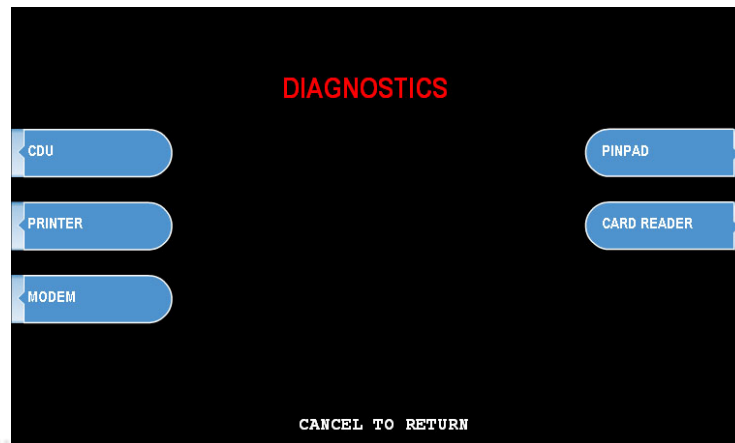

CASH DISPENSER

This will test the ability of the cash dispenser to pull a note from one or both cassettes (based on how the CDU is programmed) and send it to the reject bin. You can choose from the first cassette, second cassette or both cassettes at once.

NOTE: You must have bills entered into Settlement before running this test.

PRINTER

This test will print a test receipt. If the test is successful you should receive a receipt with three sets of sample characters for each time the test is run.

MODEM

The modem test will allow you to enter a phone number into the machine and test dial. To run the test, press the Modem button and then press Test Dial. Using the main keypad, enter a phone number to be dialed (for example your cell phone number) and then press <Enter>. The modem should dial out to the number you entered. To end the call press Modem Hang up. In most cases a failure during the modem test will relate more to phone line problems rather than the modem circuit itself.

KEYPAD

This tests the keypads of the ATM. Press the Key Matrix button and a map of all keys will display on the screen. Press the different keys on each keypad (main and LCD) and the appropriate key will blink on the screen. Pressing the <Cancel> key on the main keypad will stop this test and return to the diagnostics menu.

CARD READER

This will test the three tracks of the card scanner to ensure they are reading properly. Press the Card Scan Button, you will see a screen displaying the two ISO tracks. Swipe your ATM card (or any card with a magnetic stripe) and the information from that card will appear on the appropriate track. During normal operation of the ATM only ISO Track 2 is read, however during the card swipe test both tracks are read at once.

AGING

The aging test is used at the factory to test machines prior to shipping and for quality control. Selecting this test will cause the machine to perform all self tests for an unlimited amount of time.

You can select the options in the Aging Menu for which tests to perform what interval / number of times you want the tests to run.

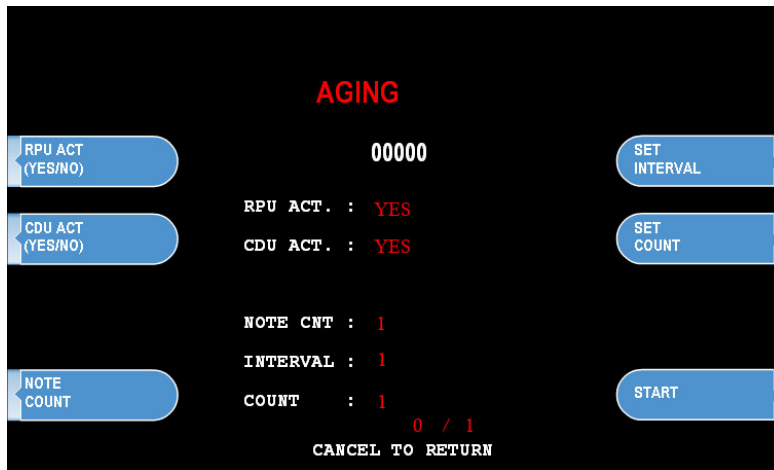

CUSTOMER TRANSACTIONS

6.1 OPENING PROCEDURES

This section explains how to place your ATM in service.

Step 1

Open the front panel and turn the power on. (see page 4.3)

Step 2

If there is no receipt paper, load the receipt paper. (see page 4.15)

Step 3

Open the security door and replenish the cash cassette. (see page 4.1)

Step 4

Go into the OPERATOR FUNCTION mode and input the number of bills in the cash cassette. (See page 4.17)

Step 5

Exit the OPERATOR FUNCTION MODE.

Step 6

After connecting to the processor, the terminal will be ready for service.

Step 7

If the machine is not ready for service, please check the following:

- Read the error message on the screen and follow any instructions.
 - Determine if the phone line is working or internet connection is properly set up.
 - Determine if all Host Setup parameters are correct;
 - If, after doing the above steps, the ATM is still not in service, contact your service personnel. Make sure to note any error codes that appear on the screen.
-

6.2 WITHDRAWAL TRANSACTION



Step 1

Insert the card.

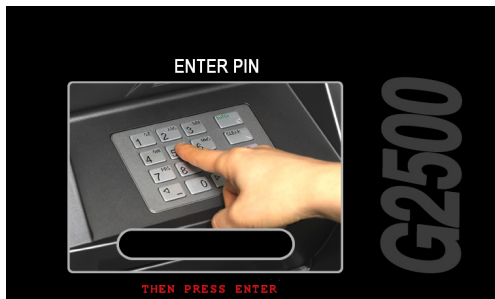

Step 2

Enter the pin number and press the “ENTER” key.

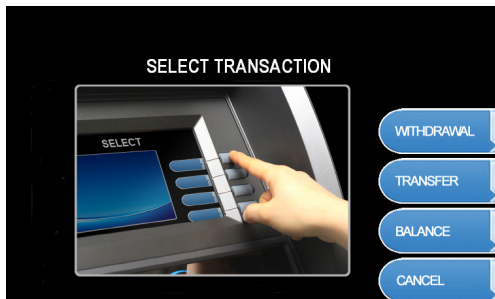

Step 3

Press the “WITHDRAWAL” screen key.

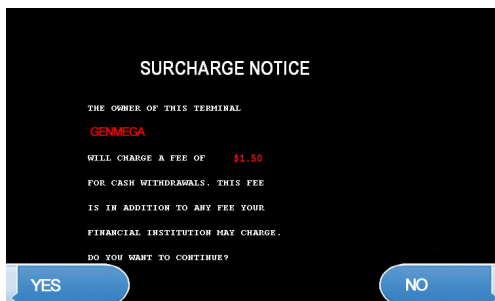

Step 4

If a “SURCHARGE” option is enabled, the “SURCHARGE” screen will be displayed. Select “YES” to continue, or “NO” to cancel.



Step 5

If “YES” is selected, the following screen will be displayed. Select the desired option.

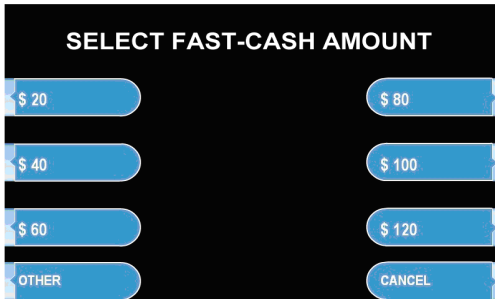

Step 6

Select the desired amount to be withdrawn. If the desired amount is not displayed, select the “OTHER” screen key.



Step 7

After the desired amount is entered, the ATM dials the processor and requests approval for the transaction. When authorization is received from the processor, the cash will be dispensed.

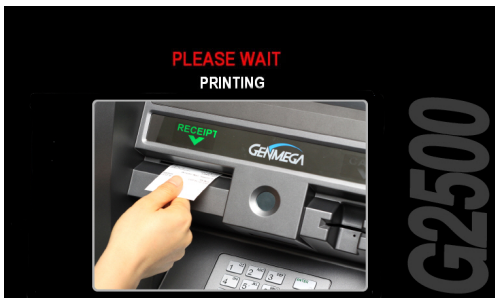

Step 8

After dispensing cash, a receipt will be printed.

6.3 BALANCE INQUIRY TRANSACTION



Step 1

Insert the card.

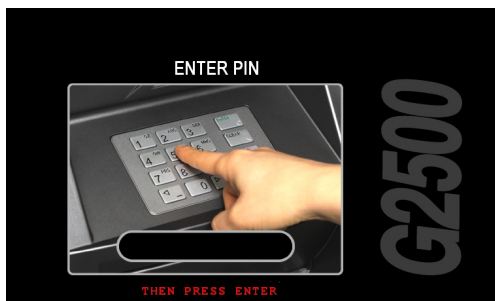

Step 2

Enter the pin number and press the “ENTER” key.

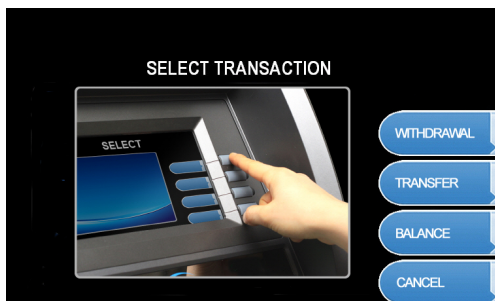

Step 3

Press the “BALANCE” screen key.



Step 4

The following screen will be displayed. Select the desired option.

**Step 5**

The ATM dials the processor and requests approval for the transaction.

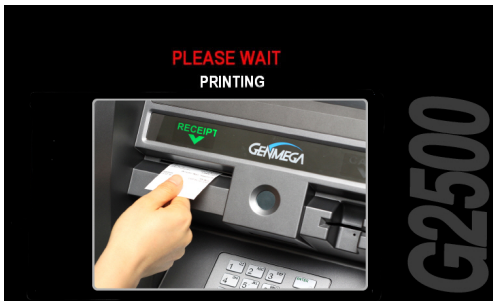
**Step 6**

When authorization is received from the processor, the following screen will be displayed and the receipt will be printed.

6.4 TRANSFER TRANSACTION



Step 1

Insert the card.



Step 2

Enter the pin number and press the “ENTER” key.

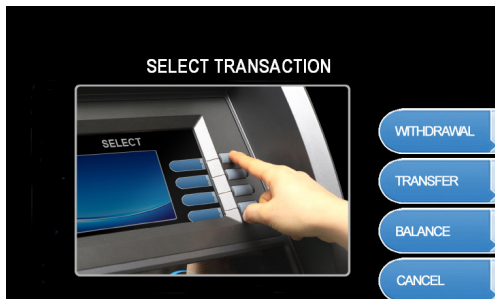

Step 3

Press the “TRANSFER” screen key.

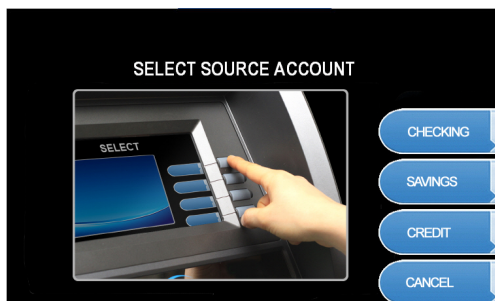

Step 4

The following screen will be displayed. Select the desired account to be transferred “FROM.”

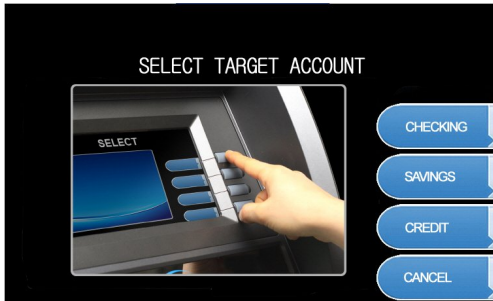

Step 5

Select the target account to be transferred “TO.”



Step 6

Enter the desired amount to be transferred and press the “ENTER” key.

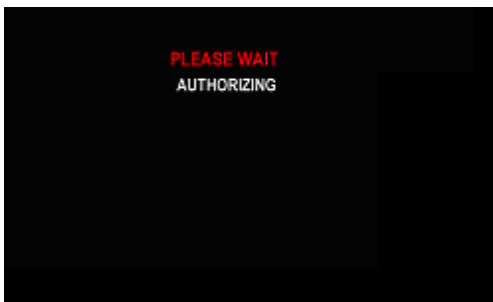

Step 7

The ATM dials the processor and requests approval for the transaction.



Step 8

When the authorization is received from the processor, the following screen will be displayed and the receipt will be printed.

6.5 CLOSING PROCEDURE

This section explains the closing procedure for the ATM.

Step 1

Perform the “DAY TOTAL” and “CASSETTE TOTAL” functions in the “OPERATOR FUNCTION MODE.”

Step 2

Open the security door. Remove the cash from the Cash Cassette and Cash Reject bin.

Step 3

Print the Journal.

Step 4

If the result of the DAY TOTAL and CASSETTE TOTAL does not match the amount counted in the Cash Cassette, refer to the Journal for verification.

Step 5

Turn the power off and close the security door.

6.6 ERROR RECOVERY

If an error occurs the following screen will be displayed.

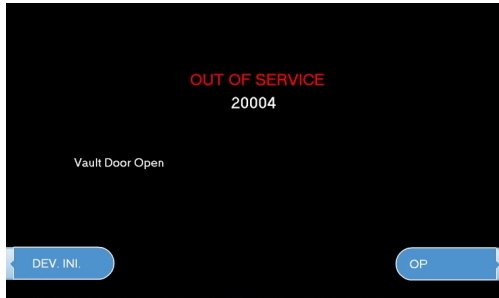

Step 1

To access the Operator Function menu, press the following keys in order <Cancel>, then <Clear>, then <Enter> then 1, then 2, then 3.

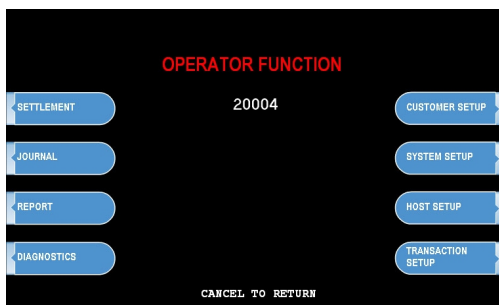

Step 2

Verify the Error that has occurred through the "ERROR CODE" of the "REPORT MENU" in the "OPERATOR FUNCTION," menu and perform the corrective action, then press the "DEVICE INITIALIZE" screen key.

If the Error is not corrected after resetting, contact your service personnel.

APPENDIX A: Error Codes

ERROR CODES	ERROR DESCRIPTION	CORRECTIVE ACTION
20001	Unable to load a cassette.	Remove and replace cassette – Check the micro-switch located on the inside left wall of the dispenser.
20002	Low Cash.	Replenish the cash – If using less than 75 bills, disable the “Low Cash Warning” in the Transaction Setup Menu.
20003	Reject Bin full.	Empty the Reject Bin – If the bin is empty, do a Day Total and then a Cassette Total – If that doesn’t help, check AP, BIOS and CDU ROM versions.
20004	Vault Door is open.	Check vault door switch (located upper left corner) – check that black and white, 2-wire connector is properly connected at rear of main board. Bend switch forward to aid closing problems.
20010	Receipt paper jam.	Remove jammed paper – Release receipt paper drawer by pressing the tab with the green sticker located at the front of the printer. Remove printer to locate difficult jams.
20012	Receipt feed lever open.	Close the feed lever on the printer.
20013	Receipt paper empty.	Replenish the paper roll.
20014	Thermal printer is overheated.	Contact manufacturer.
2xx15	Cash Dispenser detects bills prior to dispensing.	Remove any jammed bills from the dispenser.
90001	Card Swipe Error.	This does not mean the card reader is bad. Just records unsuccessful attempts at swiping cards.
Axxx1	Receipt Printer feed lever open – during operation.	Close the feed lever on the printer.
Axxx2	Thermal printer is overheated – during operation.	If problem is consistent then print head assembly may be defective.
Axxx3	Receipt paper jam.	Remove jammed paper – Release receipt paper drawer by pressing the tab with the green sticker located at the front of the printer.
Axxx4	Receipt paper is empty.	Replenish the paper roll.
Axxx5	Receipt paper is jamming during loading.	Remove any jammed paper and then reload.
Axxx8	Receipt Printer cutter error.	If consistent, printer will require repair/replacement.
ADNxx	Printer connection error.	Check cables between Printer and Mainboard. Remove cables (even though they may be attached) and reconnect.
CANCE	Surcharge Cancel	Customer has canceled the transaction at surcharge.
C0011	Exit sensor is not cleared	Check sensor, verify that the cabling plugged into the sensor boards is secure.
C0012	Reject gate timing sensor not cleared.	Check dispenser for jammed bills and reinitialize the machine.
C0013	Both reject gate and exit sensor not cleared	Check dispenser for any notes or obstructions.
C0017	Undefined	
C0021	Double detect sensor is not cleared.	Check dispenser for jammed bills and reinitialize the machine.
C0022	1 st cassette inlet sensor not cleared.	Check dispenser and cassette for jammed bills.
C0023	Cassette exit sensor (L+R) not cleared.	Check dispenser for jammed bills and reinitialize the machine.

ERROR CODES	ERROR DESCRIPTION	CORRECTIVE ACTION
C0028	Count sensors not cleared	Check dispenser for jammed bills and reinitialize the machine.
C0030	Main Motor encoder is not synchronized	Turn dispenser over by hand, and then reinitialize. May require repair.
C0031	Forward motor encoder not synchronized.	Turn dispenser over by hand, and then reinitialize. May require repair.
C0032	1 st cassette inlet sensor not cleared	Check for notes where the cassette engages the dispenser.
C0033	Undefined	
C0036	Exit sensor blocked while initializing	Clear any notes which may be blocking the exit sensor.
C0037	Invalid response (or no response) from double detect sensor	Verify the connection to the double detect module.
C0039	Solenoid not responding	Verify the function of the gate solenoid.
C003A	Too many notes requested during a test dispense	Test dispense failed, re-run the test and check notes.
C0041	Failed (5 times) to dispense a note after a successful dispense	Check why notes are rejecting following at least one successful dispense (in the same transaction).
C0042	Undefined	
C0043	10 Notes rejected in a row (single transaction)	Check the notes in the cassette. Check reject analysis for source of rejected notes (long note, double-detect, etc)
C0044	5 notes consecutively rejected	Check reject analysis for cause of rejected notes.
C0045	Note count sensor reporting mismatch	Verify count of notes in the cassette against the settlement.
C0046	Undefined	
C0047	1 st cassette failed to dispense a note	Most common reason is cassette is empty. Verify that there are notes in cassette 1. Check the quality of the notes and condition of the pick rollers.
C0049	Dispense request of "0" notes	Check setup of CDU in Operator Menu, dispenser may need reprogramming.
C004A	First cassette exit sensor (#6, #7) not clear	Clear the note path of any notes or obstructions.
C004D	1 st cassette not inserted	Check cassette and verify that it's inserted properly.
C004E	2 nd cassette not inserted	Check cassette and verify that it's inserted properly.
C0050	AP does not receive response after dispense request	AP did not validate dispense command. This is an AP software fault, not CDU.
C0051	Exceeded maximum number of notes dispensed (150) in a single trans.	Check reject analysis, and verify test dispense.
C0052	1 st cassette inlet sensor not cleared	Check for notes where the cassette engages the dispenser.
C0053	Abnormal amount of double-detect failures during dispense	Check condition of double-detect module. Check quality of notes and pick rollers.
C0054	Undefined	
C0055	Long note detected at exit sensor during dispense	Clear any jammed notes or obstructions from the exit sensor.
C0056	Short note detected at exit sensor during dispense	Clear any jammed notes or obstructions from the exit sensor; mismatch of rejected notes.

ERROR CODES	ERROR DESCRIPTION	CORRECTIVE ACTION
C005A	Undefined	
C005B	2 nd cassette fails to pick up notes	Same as C0047, the second cassette is likely empty.
C0060	3 rd cassette inlet sensor not cleared	Check for notes where the 3 rd cassette engages the dispenser.
C0062	3 rd cassette inlet sensor not cleared	Check for notes where the 3 rd cassette engages the dispenser.
C006A	Note jam at 2 nd cassette exit	Check rollers and sensors where notes would leave the 2 nd cassette.
C0070	4 th cassette inlet sensor not cleared	Check for notes where the 4 th cassette engages the dispenser.
C0072	4 th cassette inlet sensor not cleared	Check for notes where the 4 th cassette engages the dispenser.
C007A	Note jam at 4 th cassette exit	Check rollers and sensors where notes would leave the 4 th cassette.
C007C	4 th cassette fails to pick up notes	Same as C0047/C005B, verify that there are notes in the 4 th cassette.
C007D	4 th cassette not inserted	Check cassette and verify that it's inserted properly.
C0080	2 nd cassette inlet sensor not cleared	Check for notes where the 2 nd cassette engages the dispenser.
C0081	Double detect sensor not cleared while dispensing	Check double-detect sensor for note or obstruction.
C0082	Note leaving cassette exit sensor did not reach DD	A note seen at cassette exit sensors did not reach the double detect module. Check for jammed notes.
C0083	Reject gate timing sensor #2 not cleared during dispense.	Clear the note path before the reject gate.
C0084	Reject gate timing sensor #3 not cleared during dispense.	Clear the note path before the reject gate.
C0085	Note leaving DD sensor did not reach gate sensor	Check the note path for jammed or diverted notes. Check sensors from #5 to #2/#3.
C0086	Note leaving gate sensor did not reach count sensor	Check for jammed notes between #2/#3 sensors and #0/#1 sensors.
C0090	Sensor check error	Left measuring sensor A (#6/#7)
C0091	Sensor check error	Right measuring sensor B (#6/#7)
C0092	Sensor check error	Left gate timing sensor A (#2/#3)
C0093	Sensor check error	Right gate timing sensor B (#2/#3)
C0094	Sensor check error	Exit sensor (#4)
C0095	Sensor check error	Double Detect (#5)
C0096	Sensor check error	Left count sensor A (#0/#1)
C0097	Sensor check error	Right count sensor B (#0/#1)
C009A	Note jam at 3 rd cassette exit	Check rollers and sensors where notes would leave the 3 rd cassette.
C009D	3 rd cassette not inserted	Check cassette and verify that it's inserted properly.
C009F	3 rd cassette fails to pick up notes	Similar to C0047, C005B verify that there are notes in the cassette.
D0001	Modem initializing failure.	This error is reported from the host. Check that programming is correct for this processor.
D0002	Reversal transaction failed.	Check transaction with the processor. Verify CDU functionality with diagnostics. Verify phone connection.
D0012	Invalid transaction.	Network denial code.
D0013	Invalid Amount.	Network denial code.
D0014	Invalid Card Number.	Network denial code.
D0020	Surcharge screen should have been displayed.	Network denial code.

ERROR CODES	ERROR DESCRIPTION	CORRECTIVE ACTION
D0024	Exceeds issuer withdrawal limit.	Network denial code.
D0039	No credit account.	Network denial code.
D0051	Insufficient funds.	Network denial code.
D0052	No checking account.	Network denial code.
D0053	No savings account.	Network denial code.
D0054	Expired Card.	Network denial code.
D0055	Invalid PIN.	Network denial code.
D0057	Transaction not permitted – card	Network denial code.
D0058	Transaction not permitted – Terminal	Network denial code.
D0061	Exceed withdrawal limit.	Network denial code.
D0075	Number of PIN tries exceeded.	Network denial code.
D0078	No Account.	Network denial code.
D0080	Invalid Date.	Network denial code.
D0083	Cannot verify PIN.	Network denial code.
D0086	Cannot verify PIN.	Network denial code.
D0091	Bank unavailable.	Network denial code.
D0092	System unavailable.	Network denial code.
D0093	Transaction serial number mismatch.	Contact host processor.
D0094	Record format mismatch.	Contact host processor.
D0095	Routing ID mismatch.	Verify Routing ID number – Contact host processor.
D0096	Terminal ID mismatch.	Verify Terminal ID number – Contact host processor.
D0097	Response type mismatch (reversal).	Contact host processor.
D0098	Response type mismatch (day-close).	Contact host processor.
D0099	Response type mismatch (Configuration).	Contact host processor.
D009A	Response type mismatch (Withdrawal, Balance, Transfer).	Contact host processor.
D009B	STX omitted.	Contact host processor.
D009C	ETX omitted.	Contact host processor.
D009D	FS omitted (after response code).	Verify that version of ATM Software matches host processor. Contact host processor.
D009E	FS omitted (after retrieval reference number).	Verify that version of ATM Software matches host processor. Contact host processor.
D009F	FS omitted (after system trace audit number).	Verify that version of ATM Software matches host processor. Contact host processor.
D00A0	FS omitted (after account balance).	Verify that version of ATM Software matches host processor. Contact host processor.
D00A1	FS omitted (after available balance).	Verify that version of ATM Software matches host processor. Contact host processor.
D00A2	FS omitted (after available balance).	Verify that version of ATM Software matches host processor. Contact host processor.
D00A3	FS omitted (after authorization response text).	Verify that version of ATM Software matches host processor. Contact host processor.
D00A4	ETX is in wrong place.	Verify that version of ATM Software matches host processor. Contact host processor.

ERROR CODES	ERROR DESCRIPTION	CORRECTIVE ACTION
D00A5	FS omitted (after total cash dispense amount in day close).	Verify that version of ATM Software matches host processor. Contact host processor.
D00A6	FS omitted (after total non cash dispense amount in day close).	Verify that version of ATM Software matches host processor. Contact host processor.
D00A7	FS omitted (after surcharge amount in day close message).	Verify that version of ATM Software matches host processor. Contact host processor.
D00A8	FS omitted (after surcharge in configuration message).	Verify that version of ATM Software matches host processor. Contact host processor.
D00A9	ETX omitted (from configuration message).	Contact host processor.
D0300	Modem is not responding.	Verify modem function.
D1000	No Connection.	Verify modem function.
D1100	ENQ not received from host.	Contact host processor.
D1200	Transmission error.	Verify modem function.
D1300	NAK sent 3 times to host.	Verify host phone number – See D170x.
D1500	Modem connection time out – host not responding.	Verify host phone number – verify modem speed – See D170x. If consistent, it could be a defective modem.
D170x	Modem cannot support connection – excessive line noise (usually D1704/06)	Phone line connected to ATM will not support Data-communication. In line filter may fix this. Excessive EMI emissions from outside source (neon sign, freezer).
D1800	No dial tone.	Verify that incoming phone line is plugged into “line” rather than “Phone” on mainbaord. Phone line is in use or is being shared with another phone device (FAX, POS, phone)
D1900	No answer.	Verify host phone number – See D170x
D2000	Phone line busy.	Verify host phone number – call line with handset and check for busy signal – See D170x
D2100	Modem initializing error.	Check modem.
D2200	EOT not received from host.	Contact host processor.
D25xx	Network Connection	See page 3.33 of Operator Manual
E000x	RMS port failure, response time out, modem failure, no dial tone.	Verify RMS settings (Host Setup) – See D170x
F0001	Current Number of bill is 0.	Load notes into the cash cassette – use Add Cassette function in Settlement.
F0002	No Surcharge Owner set.	Set Surcharge owner – (Customer Setup)
F0003	No Surcharge Amount.	Set Surcharge amount – (Customer Setup)
F0004	No refresh time set when advertisement is enabled.	Set refresh timer – (Customer Setup)
F0005	No Advertisement text when advertisement is enabled.	Set Advertisement text – (Customer Setup)
F0006	Dispense limit set error (less than 25 notes)	Set Dispense limit – (Transaction Setup)
F0007	Denomination Set error.	Valid Denomination are \$10, \$20, \$50, \$100 – (Transaction Setup)
F0008	Fast Cash Set error (exceeded dispense limit).	Check the Fast Cash amount. (Transaction Setup)
F0009	Master Key index is invalid.	Check Master Key index – verify checksum (Host Setup)

ERROR CODES	ERROR DESCRIPTION	CORRECTIVE ACTION
F000A	Master Key is empty.	Check Master Key checksum – reinject key (Host Setup)
F000B	Host Telephone Number is not set.	Set Host Telephone Number – (Host Setup)
F000C	Error Retry timer is not set.	Set Error retry time (Host Setup)
F000D	RMS Password is not set when RMS is enabled.	Set RMS Password – (Host Setup)
F000E	RMS phone number is not set when RMS send is enabled.	Set RMS Phone number – (Host Setup)
F000F	Terminal ID is not set.	Set Terminal ID number – (Host Setup)
F0010	Routing ID is not set.	Set Routing ID number – (Host Setup)
F0011	Master Key Serial number is not set	Set Master Key serial number – (Host Setup)
F0013/ 14	NVRAM Failure	Fatal error, defective memory chip. Replace Mainboard.
F0015	Serial Number not Set	Set Serial number in Operator Menu
F0016	Master Password left at default	ATM will not go into service with the default master password. The master password must be changed from default.

APPENDIX B: CLEARING NVRAM

To clear NVRAM on the Genmega G2500™, begin by entering the Operator Function Menu using the Master Password. Next enter the Customer Setup Menu.

Press the lowest button on the right side of the LCD panel. This will give you access to the CLEAR NVRAM Menu.

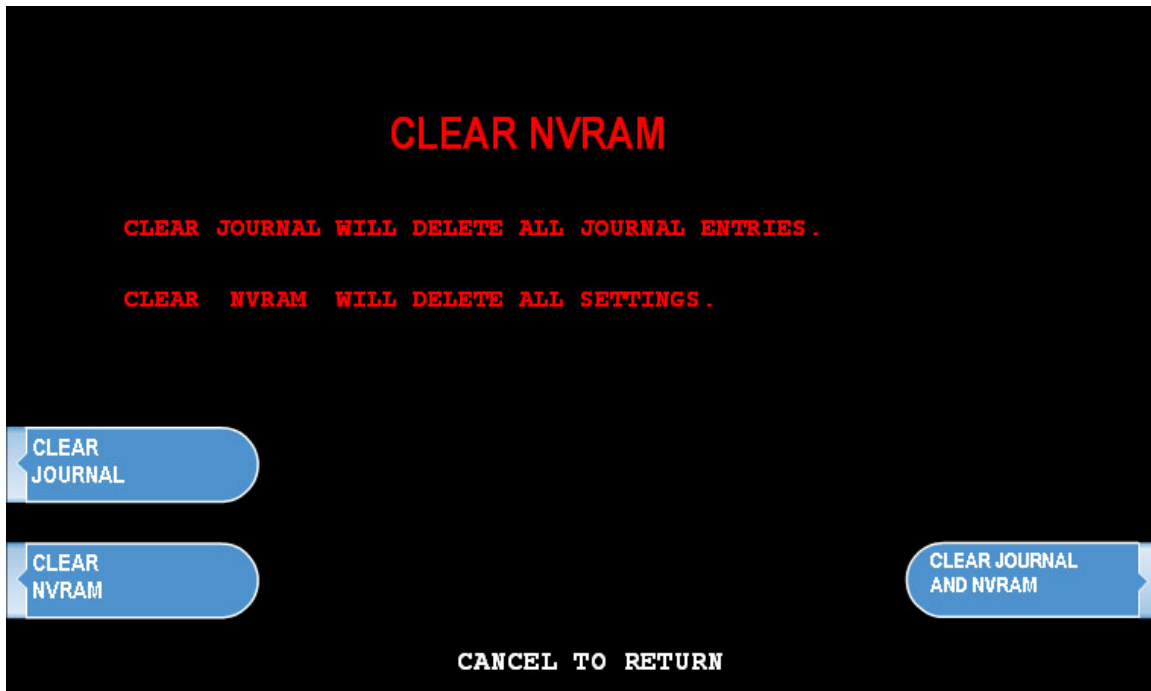

*** WARNING ***

Once in the CLEAR NVRAM Menu, there is no extra authorization before data will be wiped out permanently. DO NOT press any key within this menu unless you are absolutely sure you want to permanently delete this data!

CLEAR JOURNAL

Selecting this will delete all journal data permanently

CLEAR NVRAM

This will delete all programmed parameters and return everything (including passwords) to the default settings. This does NOT include the master keys which are stored in the EPP.

CLEAR JOURNAL AND NVRAM

This option performs both of the options listed above. Both the programmed parameters and journal are permanently deleted and all settings are returned to default.

USE CAUTION WITH THIS FEATURE – DATA LOST CANNOT BE RECOVERED

APPENDIX C: Master Key Installation

Master Key Installation

Master keys are entered only through an approved EPP (Encrypting Pin Pad) device and are stored in the keypad. These keys, along with another key downloaded from your processor are used to encrypt the 'PIN' numbers for customer transactions.

Two Passwords (Secure Mode Passwords) are required in order to enter 'Key Mode' and change any options.

NOTE: You will NOT be able to enter keys or change key mode until the Secure Mode Passwords have been changed from default. After changing both passwords, you must back out of the operator menu and reinitialize the ATM.

Please follow the procedures below to begin this process.

Installation Procedure:

To access the Key Management menu from Host Setup, you'll need to enter the Secure Mode Password (parts 1 and 2). See page 3.6 for Secure Mode instructions.

Default Secure Mode password is:

Part #1 = 000000 / Part #2 = 000000

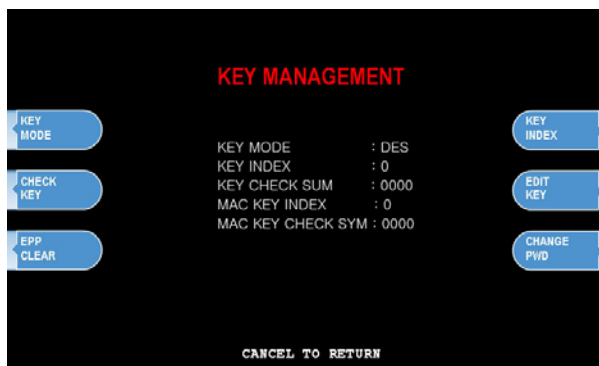

Access the Key Mode selections by entering the operator function menu

[ENTER]+[CLEAR]+[CANCEL] + 1 + 2 + 3

Enter Master Password and choose Host Setup

Note: Master Password is required to access Key Management Menu.

NOTE: You must change the Secure Mode Password from default before any changes can be made to Key Management, or enter any keys. Change the default passwords for Part #1 and Part #2 and then completely exit the Operator Menu (cancel out and let machine initialize) Once you go back in and use the new Secure Mode Passwords, you'll be able to make changes or enter keys.

1) Select Key Mode

The table below describes the format for each key mode.

DES	2 - 16 digit master keys entered as Part A and Part B.
Dual Master Key	2 - 16 digit master keys entered as Part A and Part B (a common key is entered, and then a working key is downloaded from the host).
Unique Key, DES	2 - 16 digit master keys entered as Part A and Part B - with 10 digit unique serial number entered prior to each part.
TDES	2 – 32 digit master keys entered in 16 digit pieces, Part A (left and right) and Part B (left and right)
Unique Key, TDES	2 – 32 digit master keys entered in 16 digit pieces, Part A (left and right) and Part B (left and right) - 10 digit unique serial number entered prior to each part.
MAC	2 -16 digit master keys entered as Part A and Part B, with 2 additional 16 digit numbers entered as MAC Part A and Part B
Unique Key, MAC	2 -16 digit master keys entered as Part A and Part B, with 2 additional 16 digit numbers entered as MAC Part A and Part B - 10 digit unique serial number entered prior to each part of the master key only.
TDES, MAC	2 – 32 digit master keys entered in 16 digit pieces, Part A (left and right) and Part B (left and right), with 2 additional 16 digit numbers entered as MAC Part A and Part B

Under most circumstances, you'll be using TDES as Key Mode.

Unique Key modes use a unique 10 digit serial number that is entered before each half of the master key to allow the processor to bind the key to the terminal ID automatically. In cases where the processor provides a serial number that is less than 10 digits, zeros must be added at the beginning of the number to equal 10 digits.

2) Entering A Master Key

Master Key security requires that no one person has access to all parts of the key. To ensure this, the processor will provide keys in separate sealed envelopes (sometimes referred to as “key components”). Each envelope contains either one or two 16 digit keys and in the case of unique key, a serial number. The diagram below shows a sample Unique Key, TDES master key.

Date: 5/15/2011
 Serial #: 123456
 Chk Digits: L:0427 R:0521 3D:A123FF

Left Part = 2314 AB04 88ED C107	Right Part = 49FA 001C 3826 07B5
Left Check Digit = AF16	Right Check Digit = 811C

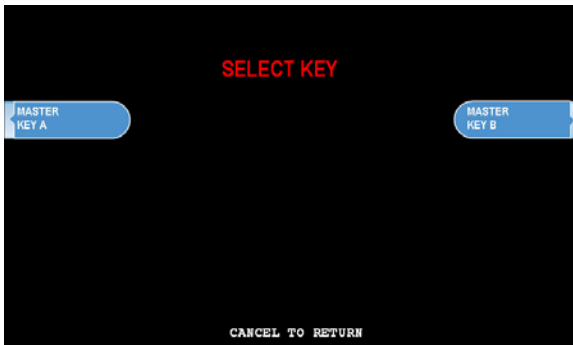

Begin by choosing Edit Master Key from the menu

Depending on Key Mode, the menu prompts for Part A and Part B.

The Edit Master Key interface is designed so that Parts A and B can be entered at completely different times and in either order (Part A first, or Part B first). If a technician is dispatched to enter a key part, choose Check Key from the Key Management menu to determine which part of the key has already been entered.

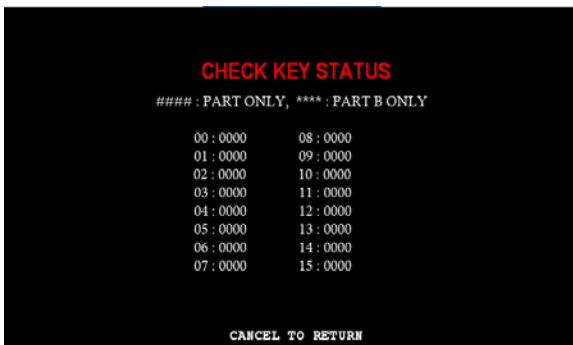

Partially entered keys will appear in the index as #### or **** which denotes that either part A or part B has been successfully entered. (A = #, B = *)

This would tell the second technician that they need to enter their key as Part B on index 12.

Part1 = Part A / Part2 = Part B



Once you have selected Part A or B, you'll be prompted to enter a Key Index.

This index points to the location where the key will be stored. There are 16 possible memory locations (0-15) available. Unique master keys must be stored at location #12, and MAC keys at location #15.

The interface will default the values for Unique and MAC keys regardless of what you enter. It is very important to remember that both parts of a key must be entered on the same index. If you enter Part A on index #2 and Part B on index #3 the key will not be complete. Use the Check Key function (shown above) to determine where your keys parts have been entered.



If entering a Unique key, next you'll be prompted to enter the key serial number.

This 10 digit number is found on the paperwork containing your master key(s). If the number the processor has provided is less than 10 digits, you'll need to add zeros to the **beginning** of the number to equal 10 digits.

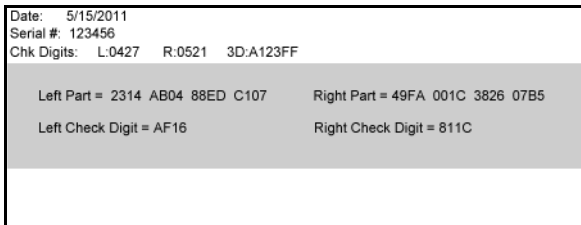

In the example shown at left, the serial number is 123456. This 6 digit number would be changed to 0000123456 to create 10 digits.



The next step is to enter the master key itself. If you are using TDES, you'll need to enter the left portion first.

After entering the key, you'll be prompted to enter it a second time for verification.

Date: 5/15/2011	
Serial #: 123456	
Chk Digits: L:0427 R:0521 3D:A123FF	
Left Part = 2314 AB04 88ED C107	Right Part = 49FA 001C 3826 07B5
Left Check Digit = AF16	Right Check Digit = 811C

The 16 digit alpha-numeric key is entered using the pin-pad only.

Letters are entered by using the arrow and function keys. Use the pin-pad layout below.

1	2	3	D
4	5	6	E
7	8	9	F
A	0	B	C

EPP (Encrypted Pin Pad) Master Key Alpha-Numeric Key Layout

At this point the left (or first 16 digit) portion of the master key has been entered successfully.



If you are entering a 32 bit key (TDES), the second or "Right" half of the key is entered next.

This option will only appear when in TDES mode.

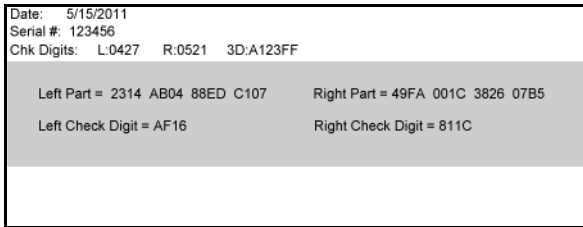

After entering the right portion of the key successfully you'll be prompted with a check digit as shown below. Verify the check digit with the information provided by the processor.

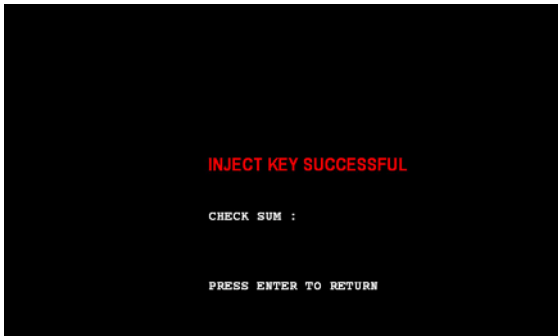

Check digits appear after entering both the right and left portion of each part of the key.

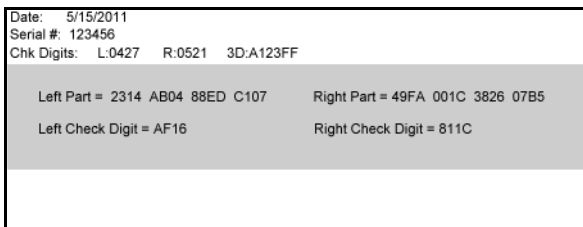

Compare the check digit against the number located at the top of the key component. This represents a check digit for the combined keys. There is not a check digit shown for left and right portions individually.

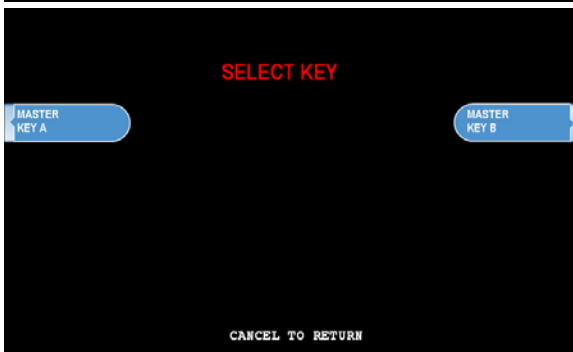

After successfully entering both the left and right portions of Part A, you'll be returned to the Edit Master Key menu.

At this point you can proceed with Part B, or if Part B is to be entered at a later time you can exit the menu and power off the machine until both halves of the key are entered.

Part B is entered with the same procedure given for Part A. Enter the left and right (for TDES) portions of the keys and verify the check digits against what has been provided by the processor.

3) Verifying Master Key

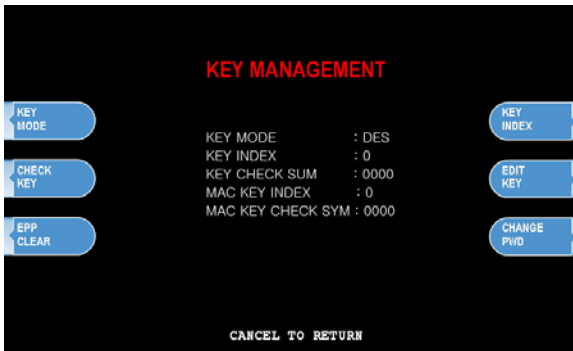

Once both Part A and Part B have been entered successfully, the key management menu will display a check digit for the key index where the master key was entered. If no check digit is entered, use the check key screen to determine where the key parts were entered, then re-enter the keys as necessary.

At this point, the master key is successfully entered. If all other parameters have been entered properly, power off the ATM and power on to connect to host and initialize the keys.

APPENDIX D: Custom Screen / Coupon Graphics

Advertisement screens can be loaded to the Genmega G2500™ machine either using a SDRAM card (at the ATM) or by using remote monitoring software (to load remotely). Please see below for basic file format specifications and instructions for use with a SDRAM card.



Center Advertisement Graphic

Width : 422 Pixels

Height : 309 Pixels

File Name

center1.bmp

center2.bmp

.....

center8.bmp (default on)

File Size : 204,888 BYTES

bmp File Format

: 8bit (256 colors) BMP

: No Compression

You can have up to 8 center graphic files and must be named as followed:

center1.bmp, center2.bmp, and so on up to center8.bmp

- ***DO NOT use more than 256 colors when creating the graphic images. The G2500™ was designed to use graphics of that format for efficiency and best performance****

Loading Graphics using SD (Secure Digital) card



SD card should be less than 2GB capacity and formatted as FAT or FAT16 file system

SD card reader is required to load files from your PC

To prepare the SD card for uploading graphics.

1. Remove all the data from the SD card.
2. Create a blank file called **update.acu** and save it on the card.

To create this file:

- a. Open up a blank notepad document.
[Start → All Programs → Accessories → Notepad]
- b. Save the blank document as “**update.txt**” in the SD card.

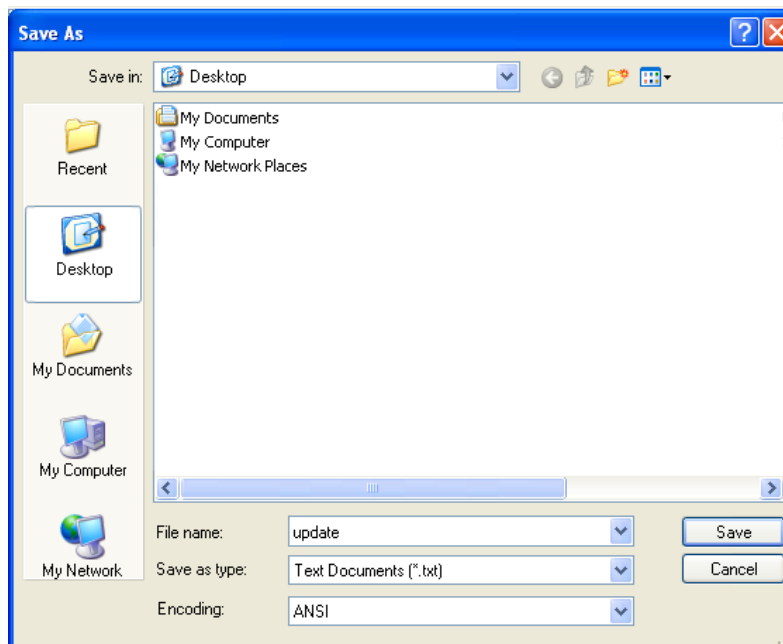

- c. Once it's saved rename the file to “**update.acu**”.



once renamed, the icon changes



After the “**update.acu**” file has been created, copy it to the root folder of the SD card.

3. Open the SD card in 'My Computer', and create a folder called "Common".
4. Open the "Common" folder, and create a sub-folder called "img4SCR".
5. Inside the img4SCR folder is where you want to copy all your graphic files.
 - The graphic files must follow the naming convention that we describe on page 1. (ie: center1.bmp, center2.bmp or top1.bmp, top2.bmp).
6. Once your graphic files are copied, insert the SD card into the SD card slot on the mainboard located behind the LCD.
7. Power off, then power on the 2500™ with the power supply switch.
8. When the ATM is fully initialized then remove the SD card.

Enabling the Center Graphics:

1. Go into the Operator Menu.
2. Then to Customer Setup > Graphics > **Advertise** EN/Disable and go through each advertisement you want to show up and turn it ON.

Enabling the Banners Graphics:

1. Go into the Operator Menu.
2. Then to Customer Setup > Graphics > **Banner** EN/Disable and go through each banner you want to show up and turn it ON.

Windows XP users:

Before creating the file in step #2, you may need to change your file options. Open a folder and click on "Tools", select Folder Options

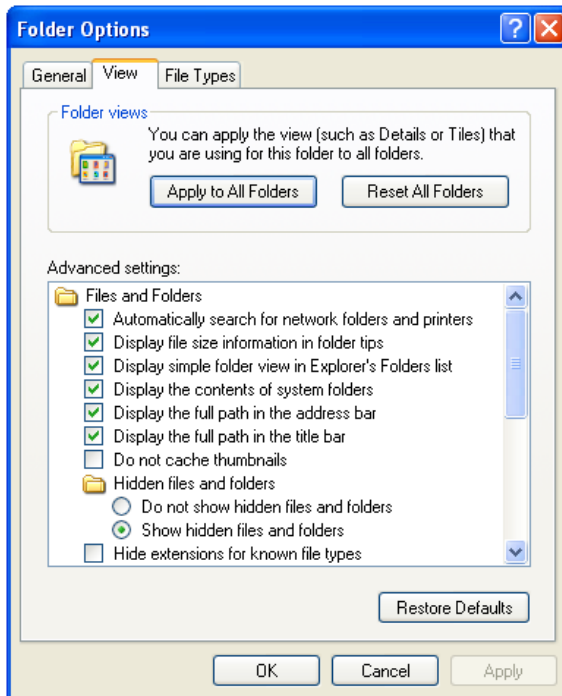

Make sure Folder Options match those shown here. Specifically the "Hide extensions for known file types" option which needs to be unchecked.

If these options are not set properly, the update.acu file may not function, causing the graphics to not load.

How to install Coupon Graphic

If ordered with the optional 3" wide receipt printer, the G2500 is capable of printing a low resolution graphic on each receipt.

To use this feature, you'll need to create the graphic (BMP file format) to the specifications listed below, and then add the file to the machine using the SD RAM card slot located on the rear of the main circuit board.

Once the graphic is loaded, it will copy into memory each time the machine is powered on. This eliminates the need to copy the graphic each time a receipt is printed.

File Specification

File Format: 2 color (1bit) bmp
Maximum Image Width: 576 pixels
Height: Variable (depends on the width)
Maximum file size: 16KB
Maximum Dimensions: 576 pixels (W) x 222 pixels (H)
File Name = Logolmg.bmp (save file as)

**** Please note that the maximum file size is CRITICAL.****
You cannot exceed 16KB. Adjust the height and width of your graphic to ensure it's under that size cap. Also, 2 color graphics mean white and black only, do not use grey-scale.

File location on G2500 (download image with SD CARD)

From the root of the SD CARD:
Common\lmg4SCR\Logolmg.bmp

Copy the file from your PC to that path on the SD Card. If the SD card is otherwise blank, you'll need to create a blank file (with notepad) called update.acu. Open up notepad with a new blank file and then "Save As" and name it update.acu and save it to the root of the SD Card. The presence of that file in the root tells the G2500 to copy the graphic file into memory.

Once the graphic file has been uploaded to the machine, you need to enable it within the Operator Function Menu.

Customer Setup → Coupon Setting Logo → Enable

Once this has been done, upon exiting the Operator Menu, you'll see a notice that the graphic is being loaded into memory. This screen will reappear each time you power off and on the ATM.